

# Swimming 6

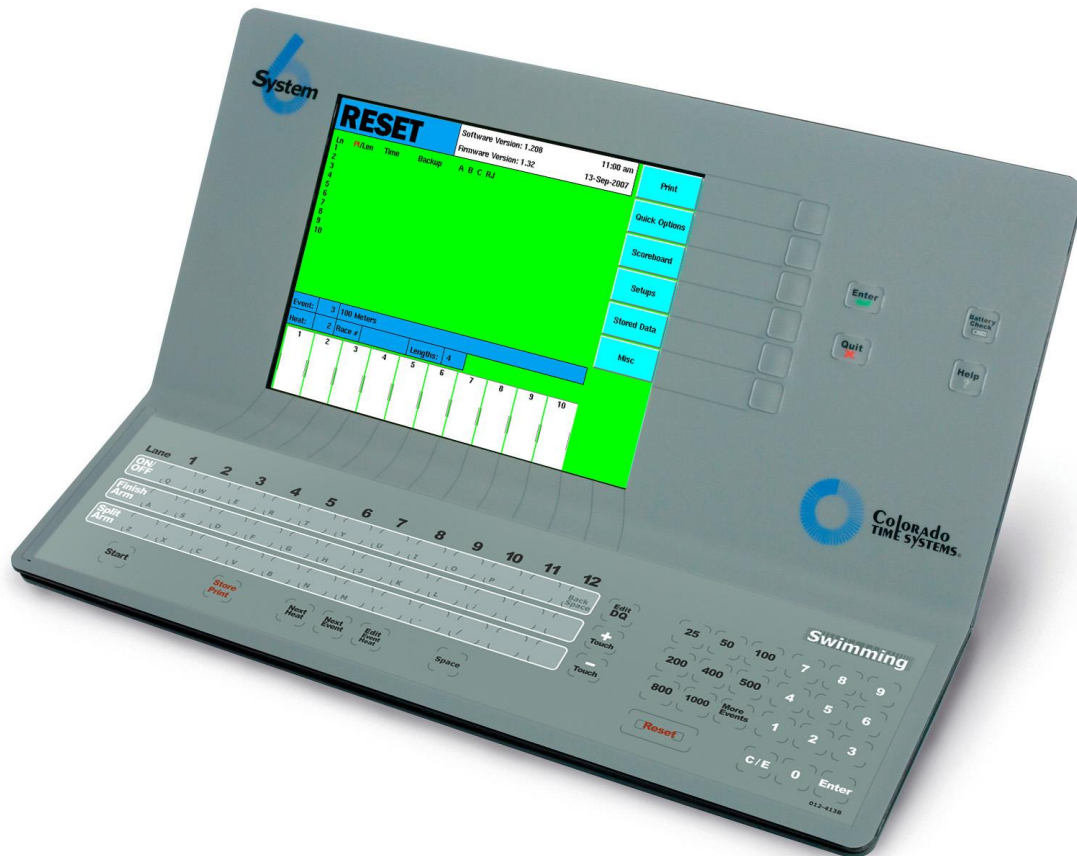

## For The System 6 Sports Timer Software User Guide

F870 Rev. 201501



**Colorado  
TIME SYSTEMS**  
A **PLAYCORE** Company

**Customer Service Department**  
www.coloradotime.com  
Email: customerservice@coloradotime.com  
Phone: +1 970-667-1000  
Toll Free U.S. and Canada 800-287-0653  
Fax: 970-667-1032

Colorado Time Systems

Corporate Office  
1551 East 11th Street  
Loveland, CO 80537 USA

Sales: 800-279-0111 or +1 970-667-1000

Service: 1-800-287-0653 or +1 970-667-1000  
Service Fax: 970-667-1032

Web: [www.coloradotime.com](http://www.coloradotime.com)  
Email: [customerservice@coloradotime.com](mailto:customerservice@coloradotime.com)

IBM is a registered trademark of IBM Corporation. Epson is a registered trademark of Epson America, Inc. Lime-A-Way is a registered trademark of Benckiser Consumer Products, Inc.

Part Number F870, Rev. 201501  
©2015. Colorado Time Systems. All rights reserved.

Table of Contents	
Introduction.....	1
Getting To Know Your System 6 .....	1
Contents .....	3
Swimming System Hardware Setup .....	5
General Guidelines.....	5
Connect the Start System .....	5
Connect the Finish System.....	6
System Layout Diagrams .....	9
System 6 Back Panel.....	11
Scoreboard Configuration.....	14
Tutorial .....	19
Some Assumptions.....	19
Before The Race .....	19
Starting The Race.....	20
Finishing The Race .....	23
Reference.....	25
Basic Operation.....	25
User Interface.....	26
Warning Messages .....	27
Timing Problems.....	27
Timing Corrections .....	27
Relay Judging.....	28
Lower Keyboard .....	29
Lane On-Off.....	29
Finish Arm .....	30
Split Arm.....	30
Start.....	30
Store/Print .....	31
Next Heat .....	31
Next Event .....	31
Edit Event/Heat.....	32
Edit/DQ.....	32
+Touch .....	33
-Touch.....	33
Events.....	34
Reset.....	34
Numeric Keypad .....	35
Enter .....	35
C/E .....	35
Console Keys .....	35
Softkeys.....	37
Print.....	38
Quick Options .....	39
Scoreboard .....	41
Setups.....	43
Setups Softkey Menu .....	43

Stored Data.....	57
Misc.....	60
Appendix A: Maintenance .....	63
Customer Service .....	63
Factory Maintenance.....	63
Routine Maintenance .....	64
Troubleshooting .....	67
Trouble Shooting Chart.....	67
Appendix B: Glossary.....	77
Appendix C: History of Swim Timing.....	79
Appendix D: Scoreboard Definitions .....	81
Appendix E: Swimming Software Menu Tree .....	85
Index.....	89

# 1

## Introduction

You have chosen the latest sports timer from Colorado Time Systems, the company that pioneered precision and accuracy in swim timing. A legacy of excellence is behind your new timer. A brief history of swim timing is included in this manual in Appendix D.

## Getting To Know Your System 6

### **Back Panel**

After removing the System 6 from its shipping container and carrying case, take a few minutes to familiarize yourself with it. In particular, examine the areas discussed below.

A variety of output connectors are mounted on the back panel. Notice in particular those described below.

Inputs to the System 6 include:

- An external DC power supply
- Near-end cable harness (lanes 1-10) (second connector for 11-12)
- Far-end cable harness (lanes 1-10) (second connector for 11-12)
- Duplicate Near- and Far-end cable harnesses to attach a second timer for backup
- Judges I/O port
- Keyboard & Mouse

Outputs from the System 6 include:

- Scoreboard
- Com port for computer running meet management software
- Printer port
- External monitor
- 3½ disc drive (on older models) for optional storage of older files
- Ethernet port for online software updates
- USB port (on newer models) for storage to a USB device, or to connect a USB printer. Please see the Sport Loader manual for details.

## **Liquid Crystal Display (LCD) Screen**

Turn on your System 6 and load the Swimming program (refer to page 25, “Running Swimming,” for loading instructions). The display screen provides you with a wide range of information to help run your swim meets.

The screen always displays current race information including running time, the status of the race, event and heat numbers and more. The Swimming software keeps you in full control of the race situation at all times.

## **Battery**

An internal lithium ion battery provides backup power in case of emergency or power outage. To charge the battery, plug the System 6 into a grounded power outlet with the unit turned off. The charge time of the battery is 3 hours. The battery will provide approximately 45 minutes of usage time. This can be increased to 1 hour after 4 to 5 cycles of fully charging and fully discharging. If you are discharging the battery, exit Swimming and let the timer run until it dies.

## **Softkeys**

The softkeys located to the right of the display screen let you select from a variety of options. You can:

- Select the kind and format of printed race information.
- Print a sponsor’s message on race printouts
- Display detailed race information including backup button input and Relay judging information.
- Access special scoreboard control features.
- Customize the Swimming software to meet your individual needs.
- All setup information can be stored in memory for future races.
- Program standard or special event sequences.

## **Keyboard Insert**

The keyboard insert helps you run meets efficiently. You can:

- Turn lanes on and off quickly with a single keystroke.
- Quickly recover from missed or inadvertent touchpad hits.
- Store and print race information with a single keystroke.
- Edit times and enter DQ information.
- Change the length of an event quickly and easily.

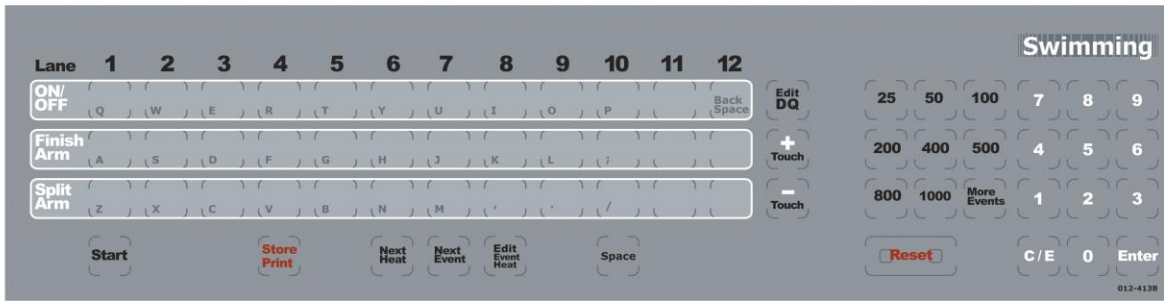

Figure 1-B Swimming Keyboard Insert

Now that you are familiar with your System 6 Sports Timer and Swimming software we encourage you to continue reading this manual at your convenience.

### **Scope Of This Manual**

This manual is intended to address all issues related to the normal operation of the System 6 with the Swimming software. It is written with the beginning timer operator in mind, but it also contains detailed information on advanced operations which are of interest to the experienced operator. Use the index to locate specific information quickly.

A complete Maintenance section covers the most common problems that are user correctable. For any repairs or problems not found in the manual, call Colorado Time Systems' Customer Service Department at 800-287-0653 (U.S. and Canada) or 970-667-1000 (International).

## **Contents**

### **Chapter 1**

Contains introductory information and an overview of the System 6 Sports Timer/Swimming software and the scope of the instruction manual.

### **Chapter 2**

Covers hardware setup of your total system in preparation for a swim meet. The instructions relating to equipment other than the System 6 are general in nature and are not intended to serve as a substitute for the manual(s) accompanying your accessory software and hardware.

### **Chapter 3**

A step-by-step race tutorial, the purpose of which is to acquaint you with commonly used features and options available in the Swimming software.

## **Chapter 4**

The most detailed chapter in this manual, Chapter 4 is the Reference section which describes in detail the operation of the Swimming software and the action of each key and option. This chapter includes complete information on Setups and the keyboard insert.

## **Appendix A**

Maintenance. A logically organized, step-by-step maintenance and troubleshooting reference that describes the symptoms, causes and cures for the most frequently encountered user-serviceable problems.

## **Appendix B**

Glossary. This appendix contains a glossary of terms relating to the Swimming software and the System 6.

## **Appendix C**

History of Swim Timing. A historical perspective of swim timing.

## **Appendix D**

Scoreboard Definitions. This appendix provides information regarding the defining of scoreboard modules.

## **Appendix E**

Menu Tree. This appendix provides an easy-to-read guide, which shows the progression of options displayed on the softkeys.

## **Index**

A complete index provides quick access to specific information. The index is cross-referenced and organized to make finding any information in this manual fast and easy.





- 1) To set up a loudspeaker start system, place the start system a safe distance from the pool and plug in the microphone. Route the loudspeaker cable harness along the edge of the pool and connect the speaker(s) to the harness, as shown in Figure 2-G
- 2) Connect the cable from the start system to the start connection on the primary cable harness as shown in Figure 2-A, or to the start connector on the wall-plate or your in-deck wiring system.
- 3) If you are using a backup start button, plug it into the connector marked “Backup Start” on the primary cable harness. Refer to Figure 2-A.

## Connect the Finish System

### **Touchpad Finish**

- 1) Place your touchpads in the water, making sure that they are securely in place on their brackets.
- 2) Route the input cable harness(es) along the pool deck as shown in Figure 2-E. Plug the touchpad connectors into the “Prime” connectors on the primary cable harness as shown in Figure 2-B. If you have an in-deck system, insert the touchpad plugs into the touchpad connectors on the deck plates.
- 3) If you are using backup button(s), insert the backup button A plugs into the button A connectors on the primary cable harness or the deckplate of an in-deck wiring system as shown 2-B.

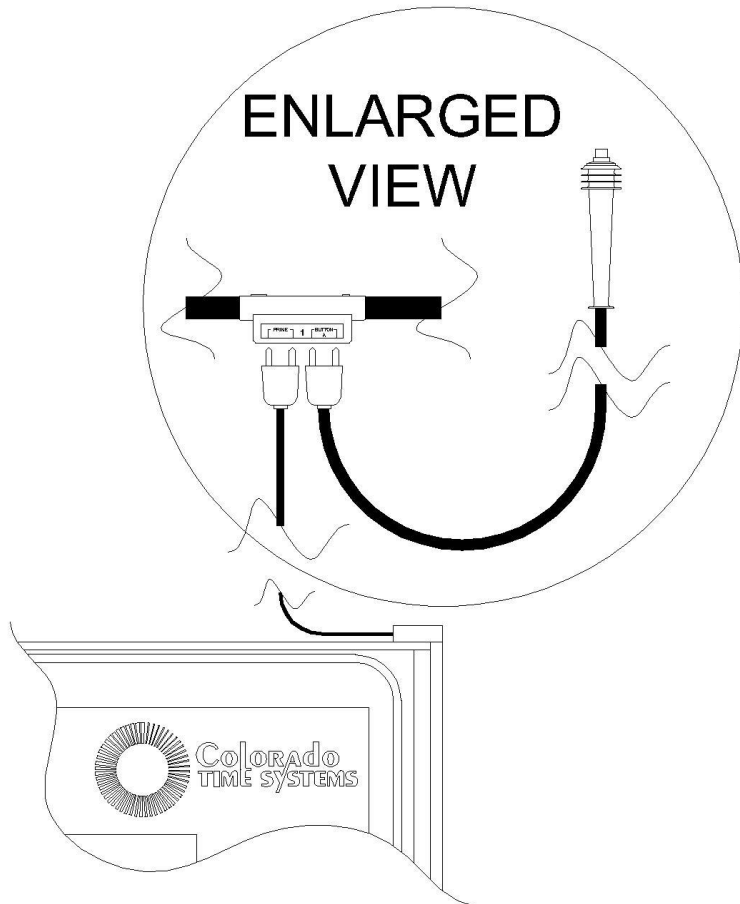

Figure 2-B Touchpad/1-Button Backup Finish

4) Connect the primary cable harness or in-deck wiring system cable to either input connector (for the appropriate end) on the I/O panel of your System 6. Figure 2-E shows a complete pad finish and one-button back-up system.

### **Button Finish**

**One Button:** Route the input cable harness along the pool deck as shown in Figure 2-F. Plug the finish button into the prime connectors on the primary cable harness. If you have an in-deck system, plug the finish button into the touchpad connector on the deck plate.

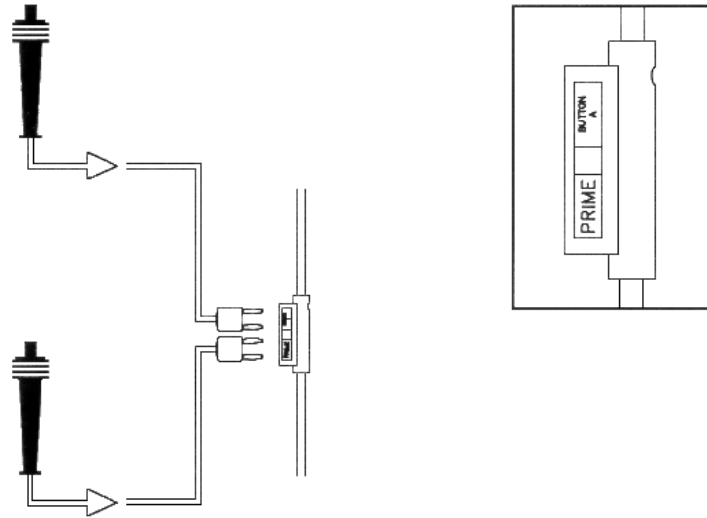

Figure 2-C Button Finish Connections

**Two Buttons:** If you are using 2 finish buttons, plug the second button into the A connector on the primary cable harness as shown in Figure 2-C. If a 2-button finish is used, the finish time is the average of the two button times recorded.

**Three Buttons:** If you are using 3 finish buttons, first, route the B and C backup button cable harness along the pool deck. Then plug the third button into the B connectors on this cable harness. The C connector will not be used.

Unlike previous systems, you do not need to select the number of buttons being used. The System 6 automatically applies the standard rule regarding button finishes (see **Start/Finish** section beginning on page 43 for more details) based on the number of inputs received.

### **B & C Backup Buttons with Touch pads**

- 1) If using a cable harness, route the B and C backup button cable harness along the pool deck. Connect the B and C backup button to the correspondingly labeled connections on the cable harness or deck plates, as shown in figures 2-D and 2-G.
- 2) Connect the B and C backup cable harness or in-deck cable into either input connector (for the appropriate end) on the I/O panel of your System 6.

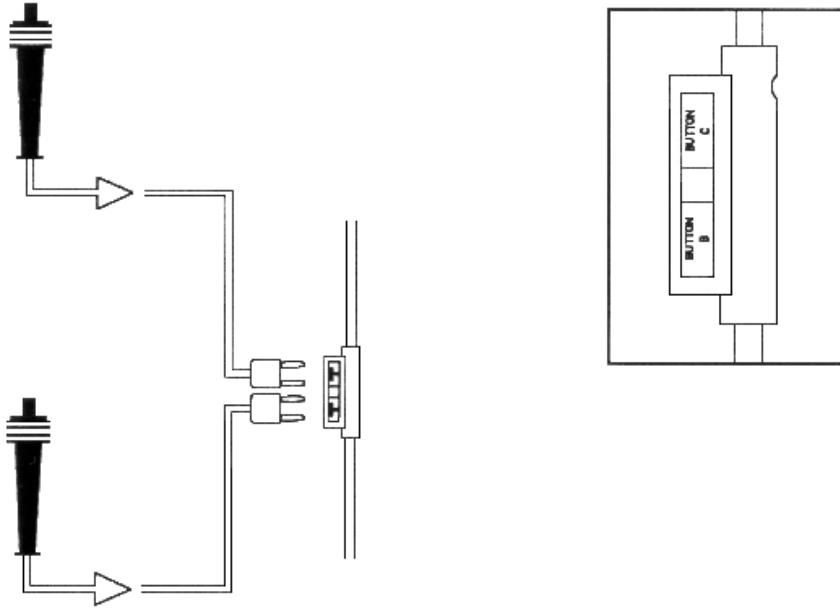

Figure 2-D Backup Buttons B & C

## System Layout Diagrams

The following three figures show sample layouts of standard swim timing systems. Use them as general references when putting together your swimming system.

### **Touchpad Finish/1 Button Backup**

This diagram shows an electronic start system and pad finish with 1 button backup. On this type of system, the start/finish software setup should be set to Near End Primary Finish = Pads. Refer to page 43, “Start/Finish Setups,” for more information on software setups.

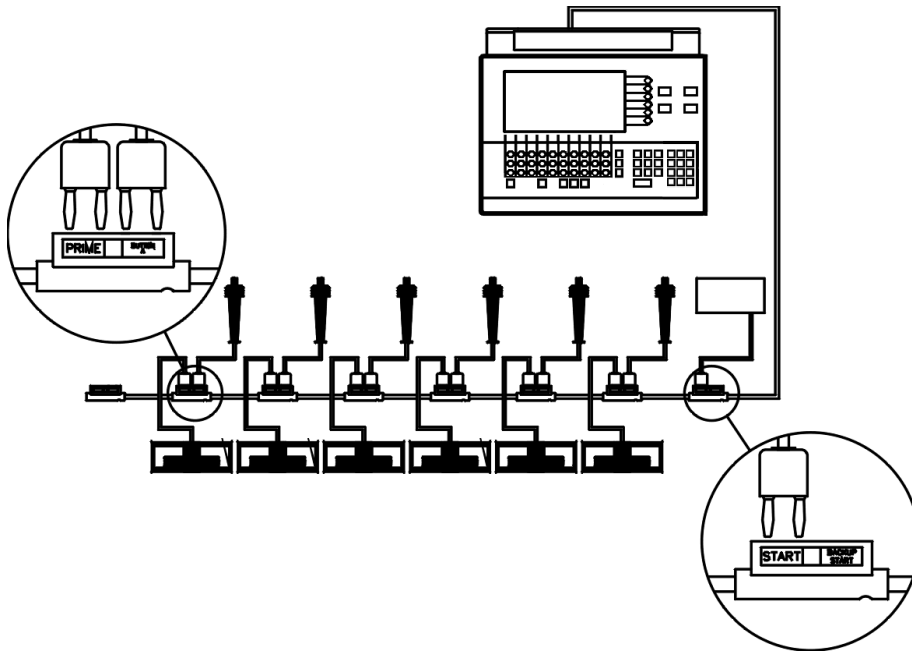

Figure 2-E Touchpad Finish/1-Button Backup

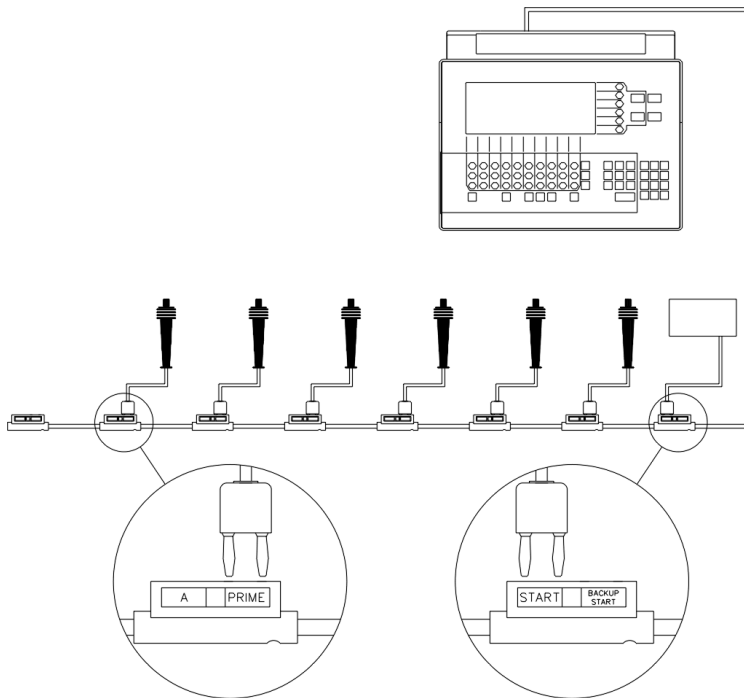

Figure 2-F Single Button Finish

### **Single Button Finish**

This diagram shows an electronic start system and a single button finish without backup buttons. “Start/Finish” Setups should be set to Near End Primary Finish = Button(s). Refer to page 43 for more information on software setups.

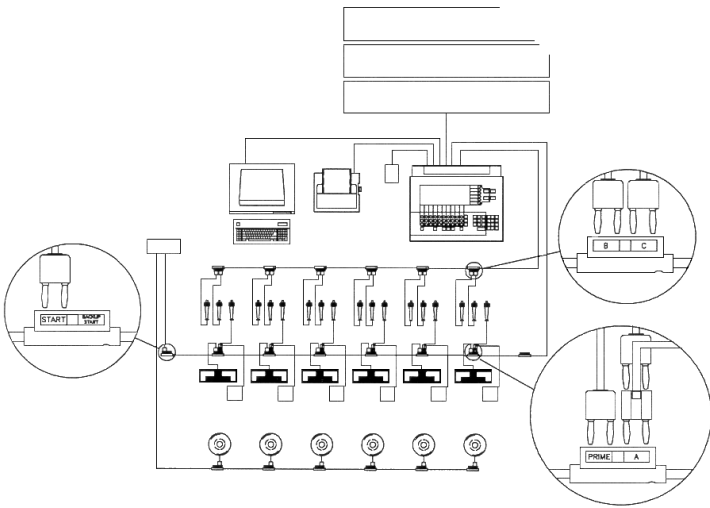

Figure 2-G Full System

## **Full System**

This diagram shows a loudspeaker start system, RJP relay judging platforms, touchpad finish with 3 backup buttons per lane, a printer, a computer running meet management software and a scoreboard. On this type of system, the “Start/Finish” Setups be set to Near End Primary Finish = Pad. Refer to page 43 for more information on software setups.

For more detailed system configuration diagrams, please visit our website at [www.coloradotime.com](http://www.coloradotime.com)

## System 6 Back Panel

The System 6 back panel houses all Input and Output (I/O) connectors. This section describes the I/O panel connectors from left to right as viewed from the back. Refer to Figure 2-H for the locations of the items described below.

**Note:** Shut Down the System6 and then turn the power off before connecting or disconnecting any cables from the I/O panel.

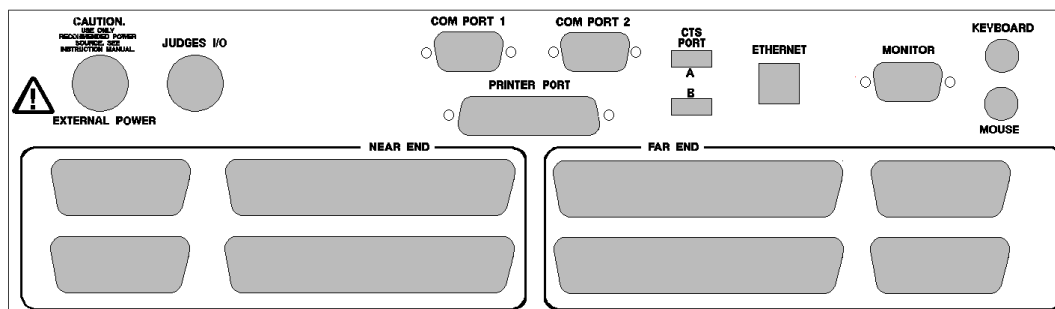

Figure 2-H System 6 I/O Panel

### **Power ON/OFF Switch**

This is the rocker switch to the side of the I/O Panel. **Do not turn off power to your System 6 while in any of the Sport Programs.**

**Important Note:** *Always follow the proper shut down procedure: Select Misc on the softkeys, then choose Change Sport, then choose Shut Down. After this, your System 6 is ready for the power to be turned off.*

### **External Power**

Connect the DIN connector from the approved 15 volt power supply (R-920-004) here. **Use only the recommended power supply!** Use of any other power supply (including a System 5 power supply) may cause serious damage to your system.

**Important Note:** *Make sure the power supply is plugged into a working AC outlet to avoid unintentionally discharging the System 6's internal batteries.*

### **Judges I/O**

This DIN connector accepts input from the Judging expansion hardware. It is also available for other expansion input/output devices for other sports made available by Colorado Time Systems.

### **Scoreboard**

The scoreboard connection is to the side of the I/O Panel just below the ON/OFF switch. Connect the cable from your scoreboard here. Push the quarter-inch jack into the socket until it snaps firmly into place.

### **Com Port 1 & 2**

Both are 9-pin standard serial communication ports which allows the System 6 to communicate with outside devices. COM1 is for a computer running swim meet management software. COM2 is used for future use.



## **Printer Port**

This is a standard IBM PC parallel port. Attach the cable from your printer to this connector. Make sure the cable connector is firmly seated and tighten the screws to make a secure connection.

If you are using a USB printer, install it by following the instructions in the Sport Loader manual.

## **Monitor**

This is a standard VGA port. If you wish to use an external monitor at the scoring table, connect the cable from your monitor to this connector. The timer's screen is displayed on this output.

## **Mouse**

This is a standard IBM PC PS-2 mouse connection. If you wish to use a mouse, connect it here.

## **Keyboard**

This is a standard IBM PC PS-2 keyboard connection. If you wish to use external keyboard, connect it here.

## **USB Port**

The USB port is used for storage to a USB device, or to connect a USB printer. Please see the Sport Loader manual for details.

## **Ethernet Port**

The Ethernet port is used for online updates to your System 6. Please see your System 6 Sport Loader manual for details.

## **Near End Input and Far End Input**

Connect the cable from the near-end touchpads, start system and backup buttons to a Near End connector. Connect the cable from the far end touchpads and backup buttons to a Far End connector. Snap the wire bails into place on the cable connectors to ensure secure connections.

The other near- and far-end ports allow the connection of a second timer as a backup unit. For this configuration, connect the near and far end inputs on the primary System 6 as described above, and then connect the other near and far end ports on the primary timer to the near and far end ports on the secondary timer.

The connectors to the left of the near end ports and to the right of the far end ports are used for near-and far-end inputs for pools with more than 10 lanes.

### **Connection to Meet Management Computer**

You will need use a “male to female 9 pin DB-9 straight through RS232 cable” to connect your System6 to your Meet Management Computer. The timer is now ready to talk to your meet management program. You will need to refer to your meet management user guide if you have any problems after this.

## Scoreboard Configuration

### **Introduction**

Colorado Time Systems' scoreboards offer great flexibility. We offer fixed digit (LED or light-reflective) displays and full-matrix LED displays. The scoreboards themselves are manufactured to withstand the rigors of the swimming pool environment and give years of trouble-free service. No routine maintenance is necessary.

The modular design of both the fixed digit and matrix displays allow your scoreboard to grow with your program and to be easily arranged to accommodate new sports. Adding new lines to the display presents no difficulty. Once the new lines are mounted, simply use the included cables to connect the scoreboards together. The examples in this chapter show many common and very useful digit arrangements for the fixed digit displays and the templates for the matrix displays.

Once you have the physical layout of your scoreboard in place, you can set the electronic configuration to display the desired information. Each scoreboard line makes up a complete display module to which the Swimming software sends specific information. You determine what information is displayed by setting the switches in each scoreboard line to the channel on which those data are transmitted. For example, the Swimming software sends race information for lane 1 on channel 01. To display that information on the first scoreboard line, as shown in the example on page 17, set the switches in your first scoreboard line to channel 01. All other channels work the same way. Your scoreboard manual contains detailed information on setting the channel switches. Refer to the figures later in this chapter for example displays from each channel.

You can also redirect data from one channel to another using the Swimming software scoreboard setup feature. Information that is ordinarily carried on one channel can be carried on another. For example, an event record time is received on channel 0B at the scoreboard. That information can be redirected to any channel, such as channel 09, which is the scoreboard module, used to display race information for lane 9. Your options are not limited. Any scoreboard information can be sent to any scoreboard module. This feature allows you to customize your scoreboard

display for special events or requirements. Refer to Scoreboard Setups on page 47 for complete instructions.

### Single-Line Scoreboard

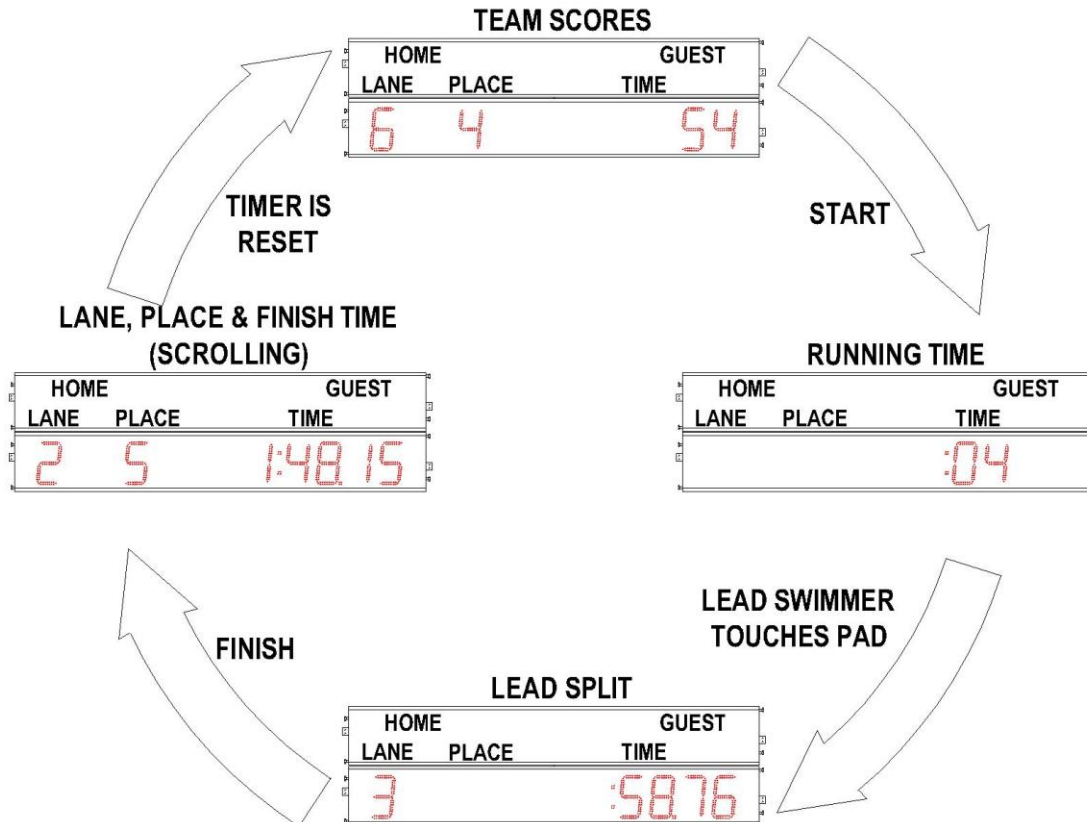

Figure 2-I Single-line Scoreboard Display Sequence

All race information can be displayed on a single-line scoreboard. The Swimming software sequences race information as shown in Figure 2-I. You can set the exact sequence used before the meet begins. Refer to the **Scoreboard** section on page 47 for more information on single-line scoreboard sequencing.

LN	HOME PL	GUEST TIME
0	0	00:00.00

Figure 2-J Single-line Scoreboard Digits/Signage

To use a single-line scoreboard display properly, the channel switch inside the scoreboard module must be set to channel 0F. Recommended arrangement of the scoreboard digits and placement of signage is shown in Figure 2-J. The data that is displayed on this module can be defined in SCOREBOARD SETUPS, One-Line Scoreboard Sequence List. The number of times this data is displayed and the duration of the display can also be set here.

Module 0F is a special-purpose multi-use module that has applications for customers who only have a single line of scoreboard, or who have multiple lines.

For scoreboards with only one line, this module allows the display of different information, depending on the status of the race. For example, while the race is running, the scoreboard will display the running time. Then, when the lead swimmer completes a lap/length, his or her split time will be displayed. Finally, as the swimmers all finish the race, their final times will be displayed in the order in which they finished. Additional information can be shown sequentially when the timer is in reset. In this way, a single-line scoreboard can effectively give the athletes, coaches and spectators all the information necessary to run a successful meet.

For scoreboards with multiple lines showing data for one lane per line, this special module can be used to display different information sequentially rotating through on a fixed interval. For example, the same board could display Time of Day and Team Scores in an alternating manner.

### **Multi-Line Scoreboard**

You can display the race information for each lane, such as lane, place and time both during and after the race.

To display race results and other information on a multi-line scoreboard, your scoreboard must be properly configured. Scoreboard configuration is a two-part process. First, the scoreboard must be installed and the digits and signage arranged to meet your needs. Refer to the figures in this section for examples of proper scoreboard arrangement and refer to your scoreboard manual for instructions on moving digits and installing signage. Once the scoreboard is installed, the channel switches in each scoreboard module must be set to agree with the channel setting in the Swimming software. For example, channel 01 in the Swimming software sends information to the scoreboard module set to channel 01, channel 02 in software sends information to the scoreboard module set to channel 02, and so on. The Swimming software uses each channel to transmit specific race information. For example, channel 01 sends the place and time information for Lane 1, channel 0C sends the event and heat information for the current race. To function properly, the switches in each scoreboard module must be set to receive the proper information.

The Swimming software provides the option to redefine a scoreboard module by sending information from one channel to another. For example, you could redefine scoreboard module 0B, which ordinarily receives record time information, to receive data from channel 06 which carries place and time information for lane 6. Refer to page 47 under “Scoreboard” in the Setups section for more details.

### **Channel Selection**

This section shows sample scoreboard module displays and the corresponding channel selections to produce them. Set the switches inside each scoreboard module to agree with the channel number listed beside it as shown in Figure 2-K. No Swimming software configuration changes are necessary.

Note: Channels 03, 0F and 16 also display the time of day when you press the **Scoreboard Blank** softkey on the Scoreboard softkey menu.

LN	PL	TIME	Channel Number	EVENT	HEAT
1	0	00:00.00	01/11*	000	000
2	0	00:00.00	02	HOME	GUEST
3	0	00:00.00	03	0D/11*	000
4	0	00:00.00	04	1	2
5	0	00:00.00	05	0E	00000000
6	0	00:00.00	06	12**	00:00.00
7	0	00:00.00	07	HOME	G1
8	0	00:00.00	08	13	00 00 00 00
9	0	00:00.00	09	HOME	GUEST 1
A	0	00:00.00	0A	14	0000 0000
b	0	00:00.00	17	GUEST 2	GUEST 3
C	0	00:00.00	18	15	0000 0000
		LENGTHS		16	00:00
		RECORD	0B		
		00			

Figure 2-K Scoreboard Displays/Channel Numbers

\*Channel 11 is a multi-purpose channel that displays time and place information for lane 1 (channel 01) during the race. Following reset, team scores (channel 0D) are automatically displayed on the same scoreboard module.

\*\*Channel 12 is a special purpose channel, which is very useful for televised broadcasts. It displays the running time, lead split time and winning finish time. Unlike channel 0F, this channel does not cycle through all finish times, but displays only winning time until it is reset.

### Display Modules

When you are done setting the channel switches in your scoreboard, check the configuration. Press 2-Show definitions on scoreboard in the Scoreboard Setup menu to display the module definitions on the scoreboard as shown in Figure 2-L. Refer to page 47 for more information.

HOME		GUEST	
0d		0d	
EVENT		HEAT	
0C		0C	
LENGTHS		RECORD	
0b		0b	
LN	PL	TIME	
0	1	01	
0	2	02	
0	3	03	
0	4	04	
0	5	05	
0	6	06	

Figure 2-L Scoreboard Displaying Module Definitions

### **System Test**

Before the first race of the meet begins, test all accessories for proper operation. Use the Diagnostics screen to test your touchpads, push buttons and start system before the meet begins. Refer to Section 4:Start-Up/Main Screen on page 25 for instructions on running these tests. Test the start system to ensure that the Swimming race timer starts as expected. Check all touchpads and backup buttons for proper operation.

# 3

## Tutorial

This chapter provides step-by-step instructions for timing a race using the Swimming software with your System 6 Sports Timer. The purpose of this chapter is to provide a basic understanding of the operation of the Swimming software under race conditions. Various aspects of the user interface are addressed, as are some commonly required operator inputs. Although the race described here is hypothetical, the circumstances covered are not uncommon in an actual race. It is important to note also that many possible occurrences are beyond the scope of this tutorial. Use this chapter only as an introduction to swim timing with the Swimming software.

### Some Assumptions

This tutorial assumes that all hardware, including touchpads, start system, scoreboard and printer are already installed and properly connected to your System 6 Sports Timer. All of these operations are described in the preceding chapter.

Our hypothetical race is a 200-meter freestyle relay event number 3, heat 2. The hypothetical pool is a 10-lane, 25-meter pool. This race, however, uses only 6 lanes. The hardware configuration consists of an electronic horn start system, near-end touchpads, 1 backup button per lane, a scoreboard and a printer.

### Before The Race

Before starting the race, turn on your System 6 and printer. Make sure your printer is loaded with paper and is ready to print on a new page.

The operator controls some functions of the System 6 with keyboard keys, and other functions with softkeys.

The keyboard keys are located on the membrane keyboard that is built in to the System 6. The removable insert identifies the function of the keyboard keys when the Swimming software is used.

The softkeys are the column of six unlabeled keys immediately to the right of the display screen. The function of each key changes depending on the option selected; the screen displays the function currently available directly to the left of each softkey. If no label appears next to a softkey, that key is inactive at the time.

To run the Swimming software, press the softkey labeled Swimming after you've turned the System 6 on. If you are changing from another sport, press the Misc softkey, then Change Sport, then Swimming. Swimming loads and is ready to operate. The timer turns ON set to Event 1 and Heat 1. If you have selected an "event sequence" the timer will be set for which ever event is #1, if you do not have a defined sequence then the timer will set itself to a 100 event. You may select another distance with the events keypad toward the right side of the keyboard and press the distance you wish. If you are re-entering the Swimming programming after exiting previously, the System 6 will be set to the next event number after the last event stored. This allows you to exit Swimming to run another program (e.g., Diving) and come back later to the point where you last were.

In its default setting, each time you press a key the System 6 beeps. If you press a key but do not hear a beep, then either the System 6 did not sense the keystroke or the beep has been turned OFF in SETUPS.

Since we are only using 6 of 10 lanes in the pool for this race, press on/off keys for lanes not being used. The active lane indicator disappears in each of the lanes turned off.

The display screen is updated to reflect the data entered.

## Starting The Race

The Swimming software is in the reset state (note the **RESET** in the upper left corner of the timer) and is ready to begin timing a race. The horn sounds, the timer starts simultaneously and the swimmers are in the pool. **Do not** press the **start** key on the Swimming keyboard unless the timer did not start. All 6 touchpads are inactive for a user-defined number of seconds after the start; this allows backstroke starts without interfering with race timing. See Chapter 4 for details of using the Setups menu to set this number. As soon as the touchpads are ready to receive a touch, the pad status display indicates armed.

The swimmers have made their turn at the far end of the pool and come in to touch at the near end. The swimmer in lane 3 touches first. When the Swimming software receives the touch pulse, it beeps and displays the number of complete lengths completed in that lane, in this case 2. The pad status indicator in lane 3 goes blank for 15 seconds (or for the number of seconds defined in Setups) to indicate the pad split delay time. During this time, the pad will not accept a touch. The System 6 beeps as each swimmer touches a pad.

### Using The +Touch Key



As the operator, you notice that the second swimmer in lane 4 has started, but the Swimming display does not indicate that the first swimmer in that lane touched the pad. Notice that there is no length display in lane 4 as in other lanes and that the color of the lane box has turned from white to orange. Figure 3-A illustrates this situation as it appears on the display screen.



Event:	3 100 Meters					
Heat:	2	Race #	[0002]	Lengths:	4	
	3	4	5	6	7	8
		Armed				
	1	0	1	1	1	1

Figure 3-A Lane 4 Pad Touch Missed

As sometimes happens, the first swimmer touched the wall beside the pad, which is a legal touch under swimming rules, but the Swimming software cannot register this as a touch.

To correct the missed pad touch, press the +touch key. The small window shown in Figure 3-B appears on the display screen prompting you to enter the lane number to which the touch should be added. Use the numeric keypad to type 4 and press enter.

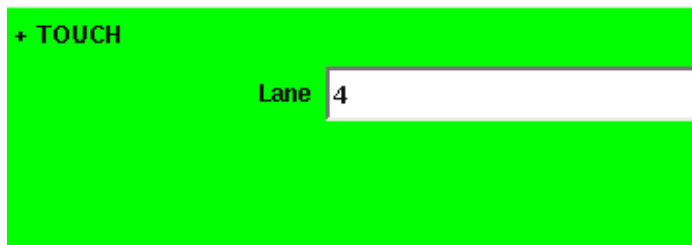

Figure 3-B Using the +Touch Key

The display screen now shows that 1 length has been completed in lane 4. The split time will be missing, but hopefully all following split times and finish time will be correct. Notice that it is not possible to finish a race using the *+touch* key. Races must be finished from the touchpads or backup buttons. There is always a reason for a missed touch. An athlete simply missing the pad is not bad but if you continue to have missed touches on the same lane you will want to determine why.

### Using Split Arm



The next situation that arises involves the second swimmer in lane 3. This swimmer is slow getting out of the pool and steps on the touchpad after its split delay time of 15 seconds is up. The pad is armed at that point and when the swimmer stands on it, a touch pulse is sent to the System 6. The display screen, Figure 3-C, now shows lane 3 having completed 6 lengths and on the finish lap.

Event:	3	200 Meters					
Heat:	2	Race #	[0003]	Lengths:	8		
		3	4	5	6	7	8
		FINISH LAP	Armed	Armed	Armed	Armed	Armed
		6	4	4	4	4	4

Figure 3-C Invalid Pad Touch in Lane 3

To correct this situation, you can press Split Arm for lane 3 which will remove the last touch and switch the pad to the ARMED status immediately. Notice that the pad status display in lane 3 has returned to Armed status and the lengths completed is revised to indicate the accurate number, in this case 4. Figure 3-D illustrates the corrected situation.

Event:	3	200 Meters					
Heat:	2	Race #	[0003]	Lengths:	8		
		3	4	5	6	7	8
		Armed	Armed	Armed	Armed	Armed	Armed
		4	4	4	4	4	4

Figure 3-D Lane 3 Reset to 4 Lengths Completed

### Using Finish Arm

*FINISH*  
*ARM* |  |  |

All swimmers touch at the end of the third leg of this race and the final leg swimmers are in the pool. The timer warns you, by showing Finish LAP, which lanes are on the last lap of the race. After the split delay each lane will display a flashing Finished Armed. The swimmers turn at the far end of the pool, you notice that lane 7 did not register a pad touch. Its length count shows 4, its pad display is not Finish Armed. Figure 3-E illustrates this situation.

Event:	3	200 Meters					
Heat:	2	Race #	[0003]	Lengths:	8		
		3	4	5	6	7	8
		Finish Armed	Finish Armed	Finish Armed	Finish Armed	Finish Armed	Finish Armed
		6	6	6	6	4	6

Figure 3-E Lane 7 Pad Touch Missed

To prepare the lane for the upcoming finish touch, press the Finish Arm key in lane 7. The length counter now displays 6 and the pad status display indicates that the pad is Finish Armed, as shown in Figure 3-F. The final split time is not accurate, but as demonstrated with the pad touch missed earlier in the race, the finish time and place pick will be accurate.

Event:	3	200 Meters					
Heat:	2	Race #	[0003]	Lengths:	8		
		3	4	5	6	7	8
		Finish Armed	Finish Armed	Finish Armed	Finish Armed	Finish Armed	Finish Armed
		6	6	6	6	6	6

Figure 3-F Updated Lane Display

## Finishing The Race

All swimmers touch their pads successfully at the finish. The System 6 beeps as each swimmer finishes and displays the place picks in each lane. As soon as the race is over, press the **Store/Print** key. As its name indicates, this key stores the race results in memory. A message appears on the lower part of the display screen (next to the race number) confirming that the results have been stored and printing of results begins immediately. If your printer does not respond shortly after of pressing the **Store/Print** key, make sure it is turned on (in the **SETUPS** area) and that the printer itself is turned on.

Finally, press **Reset** to prepare for the next race. **HINT:** hitting the Reset key will do an automatic **Store/Print** for you. There is a safety feature that will not allow a **Store/Print** or a Reset if the timer thinks that there is still a swimmer that has not finished the race.

After the race, if you wish to post the race results on the scoreboard in place order, go into the **Quick Options** menu and select the **Post Race by Place** option.

## **Shut down procedure**

When finished using the System 6, be sure to follow this shut down procedure:

- 1) On the softkey menu, choose Misc
- 2) Choose Change Sport
- 3) Confirm that you wish to leave Swimming
- 4) Choose Shut Down to from the Sport Loader menu, and press yes
- 5) Turn off the timer using the power switch on the back

# 4

## Reference

This chapter describes in detail the operation of the System 6 Sports Timer and Swimming software, the function of each key on the Swimming keyboard insert and all softkey functions.

This chapter is not meant to be read from beginning to end. It is designed to be used as a reference for specific features and functions of the Swimming software. When used in conjunction with the index at the end of this manual, this chapter provides quick access to specific, detailed information.

While it is not necessary to read the entire chapter, quickly skimming the first 14 pages will provide you with a good overview of the operation of the Swimming software, the function of the keyboard and the meaning of various items appearing on the display screen. More information on using the Swimming software appears in Chapter 3, which includes a complete race tutorial.

## Basic Operation

This section describes the basic operation of the System 6 Sports Timer and Swimming software. The different modes of operation and a basic explanation of the behavior of the timing system are included.

Upon being turned on the System 6 goes through a bootup process. After this is complete you are presented with a menu of options, called the Sport Loader menu. From here, you can start a sports program, shut down the timer, install new software or firmware, configure a USB printer on USB-enabled units, save files, change the desktop image and perform diagnostics on the timer. See the separate Sport Loader manual for details.

### **Running Swimming**

To run the system as a Swimming Timer, press the “Swimming” softkey. The Swimming program will load and is then ready to use.

# User Interface

## Summary

The System 6 Sports Timer/Swimming software user interface consists of a full-size color Liquid Crystal Display (LCD) and a membrane keyboards with removable insert.

## Operation

The Swimming program uses the LCD screen to communicate a wide range of information to you. The status of the current race is displayed at all times. Other important information displayed includes the **running time**, the **race number**, whether the timer has been **reset**, **event** and **heat** numbers, **race distance** and **type**, **lane status**, and **softkey functions** available.

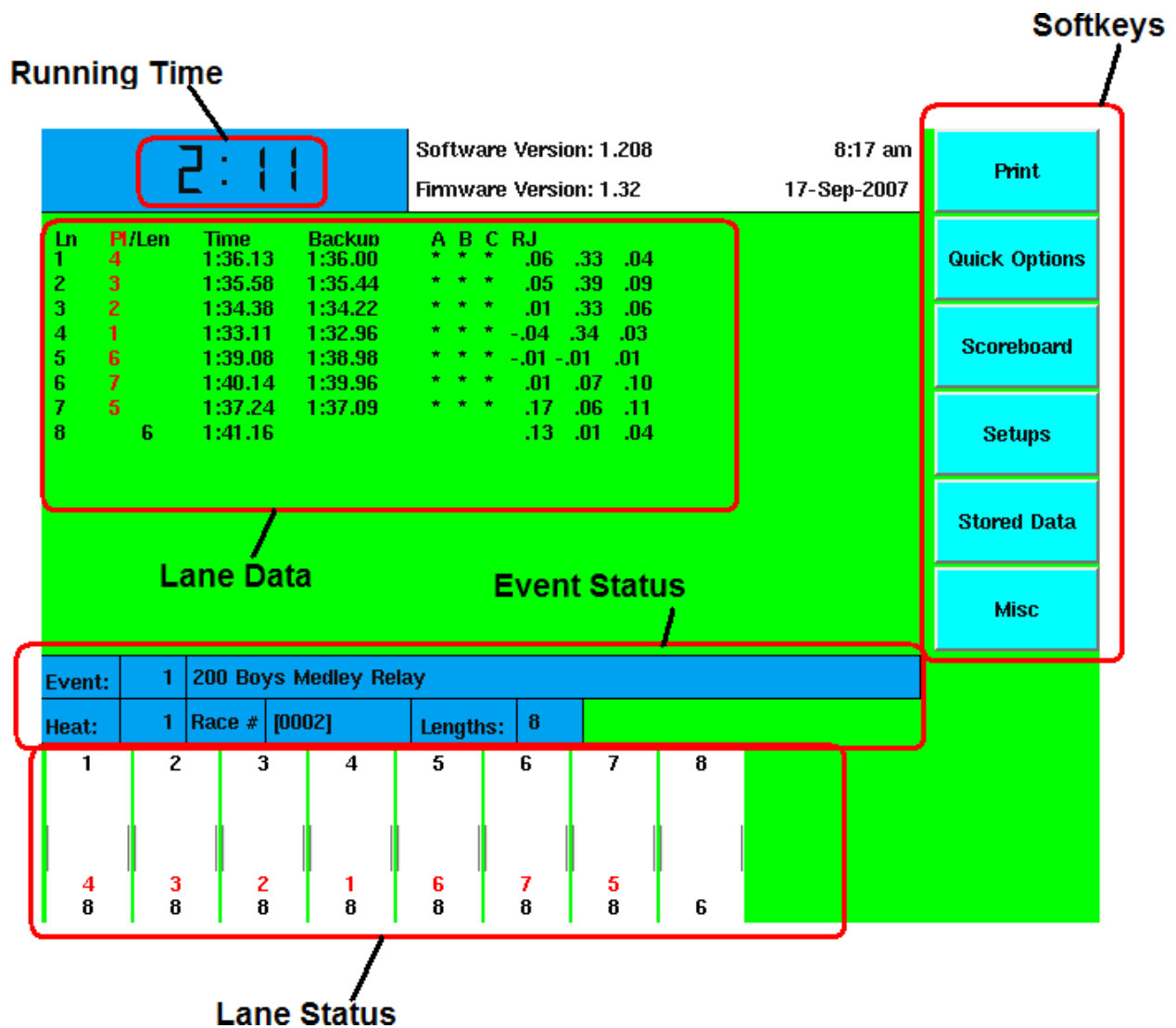

Figure 4-A Main Menu Screen with Features Labeled

# Warning Messages

## Summary

Three important warning messages can appear on the display screen, indicating a potential timing problem.

### Operation Near Pad/Far Pad

This message shows in the lane display whenever the touchpad in that lane is hit. If this is showing and no one is standing on the touchpad, this may indicate a problem with a touchpad.

### Finished Armed

When this message flashes in the lane display, it indicates that the timer thinks you are on the final lap of the race in that lane. This message continues to flash until a pad touch is received.

### Going to Internal Battery

If the timer loses its external power it will display at the bottom of the screen the message “The System 6 is operating on BATTERY!”

# Timing Problems

If timing problems are encountered during a race, such as touchpad and backup button times that do not compare properly, the screen shows the possibly questionable times in parentheses when you press *Store/Print*. Carefully check the result(s) displayed in the indicated lane(s). To use the backup time for a problem lane, press the softkey labeled *Use\_InX Backup* where "X" is the specific lane number. Press the *Edit/DQ* softkey to edit the time(s) in question. Refer to the description of the *Edit/DQ* key later in this chapter on page 59 for complete instructions. When you are satisfied that the results are accurate, press the *OK to Print* softkey to store the results and continue the meet.

# Timing Corrections

## Summary

The Swimming software is designed to correct timing inaccuracies introduced when automatic and manual timing methods are combined.

A start is considered **manual** when a person presses the start button to start the timer. In the case of a manual start, human reaction time is factored in. If an automatic start is used there is no human reaction time to compensate for. A start is considered **automatic** if the start system sends an electronic pulse to the System 6 at the start of the race. A loudspeaker start system (e.g., a CTS Infinity, ChampStart or SS-2) is an example of an automatic start system.

All button times are correct by subtracting 0.15 seconds from the recorded time. Currently some ruling bodies (particularly USA Swimming) state that all backup times must be further adjusted. The adjustment process requires that, for each lane, the differences between the pad and each button be calculated and all of this information averaged for each heat. This average must then be factored into the backup times. If the option (found in the Setups menu, Timing subsection) “Use Automatic Backup Time Adjustment” is set, this differential will be calculated and applied automatically at the end of each race. Confirm the correct setting for your meet by checking with the current rules for the appropriate ruling body.

For a complete discussion of swim timing and the statistical data and methods used to arrive at the standard correction factor, refer to *Timing Accuracies for Swimming* (© 1975 J. Killpatrick, Minneapolis, MN) and *Timing and Judging Accuracies for Swimming* (© 1976 J. Killpatrick, Minneapolis, MN).

### **Operation**

Refer to *Start/Finish* under *Setups* in this chapter, beginning on page 43, for complete information on configuring the Swimming software for your start system

## Relay Judging

Relay judging is a built-in Swimming feature. Relay judging is accomplished by humans pressing a button (“A” button) or by having an automatically Relay Judging Platform (RJP) for each lane. You need to tell the timer which type of relay judging you are using, in the *Setups* menu, *Hardware* subsection, select Relay Judging using **Platforms/Buttons (near end)** If you are using the far end you should also set that. To use Swimming's automatic relay judging feature, you must first install and connect an RJP for each lane. You do this by plugging the RJP into the “A” button of each lane in the cable harness or deck plate. You should then plug your “A” button on top of the RJP connector. Refer to your RJP Installation Guide for complete installation instructions. Refer to Figure 2-G in chapter 2 for a full system diagram.

After the relay judging platforms are installed and cabled, take the following steps to configure the timer so that the relay exchange information is printed.

- 1) Press the *Setups* softkey. Press the *Up* or *Down* softkey until the selected setup is **Printer**.
- 2) Press 1 on the numeric keypad to select **Store/Print Format**.
- 3) Press the *Choices Down* softkey until the selected item is **Relay Summary**. Press the *Insert* softkey to add “Relay Summary” to the List of details that will be printed.
- 4) Press *Quit*, and then press the *Save Setups* softkey to save the new print setup. Press *Quit* to exit Setups.



Refer to the Setups section in this chapter for complete information on Swimming setups.

The Relay Judging Platform measures the force exerted by the swimmer as they push off the starting block. Based on sensor data and high speed camera analysis, we have determined that a swimmer may still be in contact with the starting block while the force exerted is below the minimum threshold detectable by Relay Judging Platform. The duration of this “forceless” contact was never shown to be longer than 0.01 seconds. As such, an adjustment of 0.01 seconds, in favor of a safe takeoff, is added to all relay exchange times calculated by the Swimming software on all CTS Timers. This adjustment cannot be modified.

Hardware and software from other companies handle this in various ways; it is therefore most reliable to use CTS relay judging platforms with the System 6.

## Lower Keyboard

### Summary

This section describes the action of the keys on the Swimming keyboard insert. The keys are described in order as they appear from left to right on the keyboard. Refer to the Index at the end of this manual to locate a specific key description quickly. References to keyboard keys appear *bold italic* type in this manual.

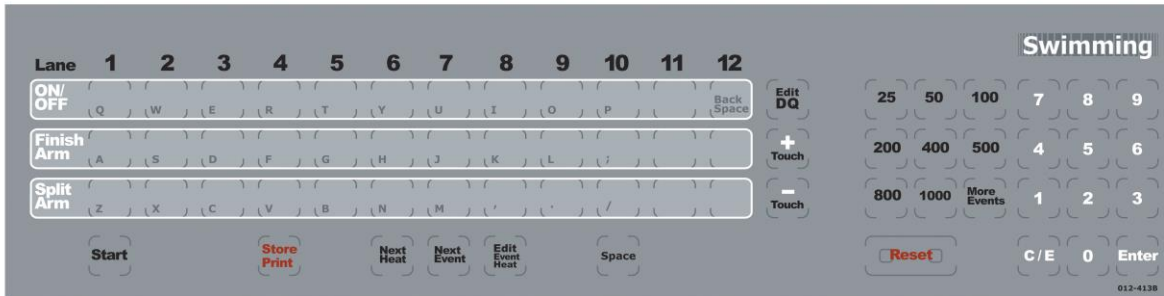

Figure 4-B Swimming Keyboard Insert

## Lane On-Off

### Function

The *lane on-off* keys are located directly under the lane numbers on the Swimming keyboard. These keys toggle output to the scoreboard and display screen from each lane **ON** or **OFF** depending on current status.

## Operation

If lane 10 is currently **off**, pressing the **On-Off** key for lane 10 will turn the lane **on**. Data are still collected from a lane when it is turned off, including running time, splits and finish time. The data collected are not sent to the scoreboard unless the lane is turned on. When a lane is turned off, its number and its status are not displayed on the Swimming screen.

# Finish Arm

## Function

Press **Finish Arm** to arm the touchpad in the selected lane for a finish touch. Use this key to arm a lane for a finish touch when the swimmer missed a split touch.

## Operation

When you press this key, the Swimming display changes the lane status to waiting for a finish touch. The display also updates the number of lengths to indicate the final lap. If pressed by mistake, you must press the **-Touch** key to return the lane to its prior state or the **Split Arm** key in that lane (see below for more information on the split arm keys).

# Split Arm

## Function

This key allows you to rearm a touchpad for a split touch after an invalid touch has occurred. It subtracts 1 from the lengths swum and arms the pad immediately.

## Operation

For example, in a relay race, a swimmer exiting the pool may trigger the pad. The pad registers a touch that is invalid. To rearm the pad for the proper split touch before the swimmer in the pool touches, press **Split Arm** in the affected lane.

# Start



## Function

This key is used as the backup start in case the primary system fail.

## Operation

Do not press this key before the primary start system has sounded. The **Start** key also allows the timing operator to start swimmers when no other start system is used.

# Store/Print



## Function

Stores the results of the race just completed in memory and prints the results. This indicates that the race is over and finalizes the race results. The **Reset** key will do this function automatically for you.

## Operation

Press this key at the end of each race to tell the Swimming software that the race is completed. The results of the current race are stored in memory and printed according to the print setup.

If you press this key before the timer thinks that all lanes have finished it will ignore you, and the Finish Arm indicator will keep flashing in the lane(s) in question. If a swimmer misses the touchpad BUT the backup buttons come in the timer will think that the race is over and we somehow missed the pad hit. In this case it will prompt you about using the backup time for the missed pad at the finish. If there was no swimmer in an unfinished lane, turn that lane off and press **Store/Print**.

If a timing problem occurs, a window appears on the display screen as indicated on page 27 (**Timing Problems**), which indicates the problem lane(s). The lane(s) in question have parentheses around the backup time. Press the **Use InX Backup** softkey, or press **edit/DQ** to edit the time in a highlighted lane. Enter the lane number and select the correct time from the softkey, menu or enter a stopwatch time with the numeric keypad. Refer to Setups to select the kinds of timing discrepancies the Swimming software is to check.

# Next Heat



Pressing this key advances the Heat counter by 1. If the “**Clear Lanes Automatically**” option is enabled, the times and places will clear from the scoreboard for all lanes when this key is pressed.

# Next Event



## Function

Press this key and the event number displayed on the screen advances by 1. When using a programmed event sequence, the race distance and type are advanced by 1 and displayed on the screen. If you are not using a programmed event sequence, be sure to set the correct race distance

before starting the next race. If the “**Clear Lanes Automatically**” option is enabled, the times and places will clear from the scoreboard for all lanes when this key is pressed.

## Edit Event/Heat



### Function

This key allows you to edit the currently displayed event and heat numbers. If the event number is changed, the heat number will reset to 1. If the event number is left unchanged, the heat number will be left unchanged as well. If the “**Clear Lanes Automatically**” option is enabled, the times and places will clear from the scoreboard for all lanes when this key is pressed.

### Operation

Press this key, type the desired event number with the numeric keypad and press *Enter*. Then type the desired heat number and press *Enter*.

## Edit/DQ



### Function

Allows you to edit times, disqualify/requalify swimmers, and designate a swimmer as a “Non-Participant.”

### Operation

To edit times, press this key and then press the *Edit Time* softkey. Type the lane number you want to edit and press *Enter*. Type the correct time and press *Enter*. Press *Quit* to close the Edit/DQ window. The Swimming software calculates any changes in finish order based on the new time.

To disqualify a swimmer from the most recent stored race, press *Edit/DQ* and then press the *DQ* softkey. Type the lane number to *DQ* using the numeric keypad and press *enter* to disqualify the swimmer in that lane. Repeat the procedure to **un-DQ** a disqualified swimmer.

To declare a specific lane as “Non-Participant,” press the *NP* softkey. Type the lane number to mark using the numeric keypad and press *Enter*. Repeat the procedure to **un-NP** a lane. This feature is only required by a few governing bodies and is not required or recommended for most meets. If you do now know whether or not you need this, you probably do not.

# +Touch



## Function

This key allows you to add a pad touch when the swimmer in a given lane missed a touch. The System 6 will indicate if a swimmer may have missed a touch by changing the color of the corresponding lane box on the screen from white to orange. The timer determines if a swimmer may have missed a touch by comparing the time for the current lap to the split time for the previous lap.

## Operation

To add a pad touch to a selected lane, press this key, type the lane number using the numeric keypad and press **Enter**. The display is immediately updated to indicate the added touch

**Note:** *A race cannot be finished from the keyboard. Therefore, this key is invalid on the finish lap.*

# -Touch



## Function

This key allows you to subtract a pad touch from the total in a given lane. Used when an invalid pad touch is recorded. For example, when a swimmer on the pool deck steps on the lip of a touchpad, triggering an invalid touch.

## Operation

To remove a pad touch from a selected lane, press this key, type the lane number using the numeric keypad and press **Enter**. The display screen is immediately updates to reflect the removed touch.

**HINT:** This function can also be done with the **Split Arm** key for each lane.

# Events

## EVENTS

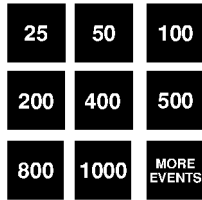

### Function

These keys allow you to enter the race distance.

### Operation

Use the numbered keys in this category to set the race distance, either in yards or meters as you have defined in Setups. Press the key corresponding to the distance desired. The race distance displayed changes to match the new distance and the race status display is updated. Press **More Events** to display more event lengths on the softkey menu then press the softkey next to the desired race distance. Press the **Other Events** softkey to set a distance other than those specified on the key pad or the softkeys under **More Events**. You will be asked to type in the distance using the numeric keypad and then press **Enter**.

At any time prior to printing, any or all lanes can be re-armed. This is very useful if you forget to change the race distance from a 50 to a 200 as a new event begins. The timer would think that the first split was the end of the race and would show a finish. As long as you have not hit **Store/Print** the clock is still running and you can merely hit the race distance key **200** and you are back in business.

# Reset



### Function

This key clears the Swimming display and prepares it for the start of the next race. It performs a **Store/Print** for you if it has not already occurred.

### Operation

The **reset** key is composed of two keys placed side-by-side. Both keys must be pressed simultaneously to reset the Swimming race display. Pressing these keys indicates that the race is over. The time is cleared for the top of the screen and the timer is ready for the start of the next

race. As a safety measure if you press *reset* during a race you will be told that the race is still going on and be asked if you really want to reset the timer.

Whenever you press reset (and accept the reset), the race is over even if a swimmer has not finished. The race is stored showing results only for the lanes that were finished before *reset* was pressed.

## Numeric Keypad

This key allows you to enter numbers in response to prompts asking for a number to be entered. The numeric keypad is located on the right of the keyboard insert on the System 6 lower keyboard.

### Enter



After a keyboard entry, press *enter* to accept the entry. This key is exactly the same as the *enter* key on the upper console.

### C/E



Press *c/e* to clear all data from a prompt line on the screen.

## Console Keys

The console keys are located to the right of the LCD screen. The unlabeled keys are referred to as softkeys, and are described in the next subsection. The labeled ones are described below.

### Enter



After typing information on the keyboard or numeric keypad, press *enter* to accept the data. This key functions exactly the same as the *enter* key on the numeric keypad.

## **Quit**

QUIT

Press this key to exit a prompt after information has been entered. This key also allows you to cancel an operation that requires an entry without changing the current settings. No information is entered if you press *quit* before pressing *enter*.

## **Battery Check**

This key **DOES NOT** function at this time.

## **Help**

HELP

## **Function**

Your Swimming software includes context-sensitive help information which is available at any time.

## **Operation**

Press this key to display useful information on the screen. The help text covers the currently active operation. Use *help* as a reminder for using a Swimming feature, and not as a replacement for this manual.



# Softkeys

## Summary

This section describes the operation of the Swimming softkeys. The softkeys are the column of six unlabeled keys immediately to the right of the display screen. The function of each key changes depending on the option selected. The screen displays the function currently available directly to the left of each softkey. If no label appears next to the softkey, that key is inactive. In this manual, softkey names appear in ***Bold-Italic*** type. See Figure 4-C for an example of the main softkey menu.

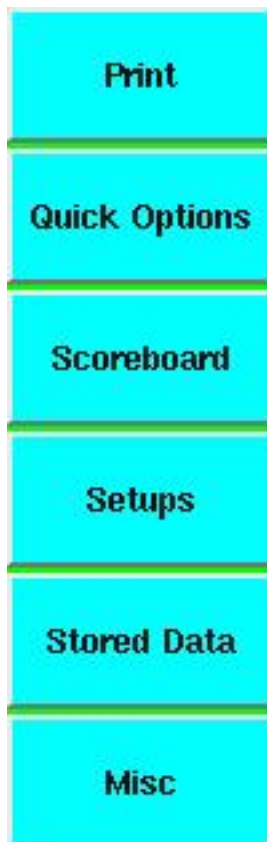

Figure 4-C Main Softkey Menu

## Operation

Each softkey's function is organized in layers or levels. The first level consists of the six softkeys displayed when you first load Swimming software. When you press one of these softkeys, a second level providing more specific choices is displayed. In general, pressing a second level softkey executes an action or prompts you for entry of data.

Appendix F, beginning on page 85, details all of the levels of the Swimming software menu with the page on which that option is explained.

If you press a softkey by mistake, or want to return to race timing mode when done using a softkey, press *Quit*. Pressing *Quit* exits without saving that entry.

# Print



## Summary

The Print softkey allows you to print additional printouts from the last stored race organized in a variety of ways. Each item is printed in the order in which you press the softkeys. Make sure your printer is on-line and loaded with paper before beginning. Print samples appear later in this chapter.

## Operation

After pressing *Store/Print*, press the *Print* softkey to access the print menus. The softkeys that make up the first print menu are shown in Figure 4-C. You may press any combination of keys available.

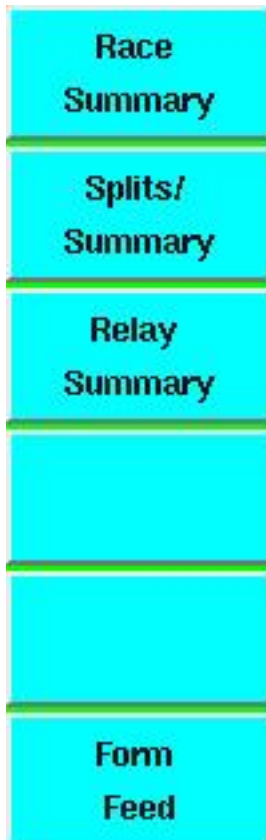

Figure 4-D Print Softkey Menu

### **Race Summary**

**Function:** Prints a copy of results sorted by both lane **and** by place.

### **Splits/Summary**

**Function:** Prints the splits, in both cumulative and subtractive form.

### **Relay Summary**

**Function:** Prints a summary of the relay exchanges.

### **Form Feed**

**Function:** Advances the paper to the top of the next page. Provides page breaks between pages of race information.

**Operation:** Press this softkey at the point in the print sequence where you want to end a page. Any information printed after a form feed begins at the top of the next page.

## Quick Options

### **Summary**

The *Quick Options* softkey provides easy access to options for the display screen, touchpads, and scoreboard.

### **Operation**

Press this softkey to display race information on-screen including the last split or finish time for each active lane. This softkey also allows you to turn far end touchpads on/off and change the scoreboard display from event/heat to home/guest.

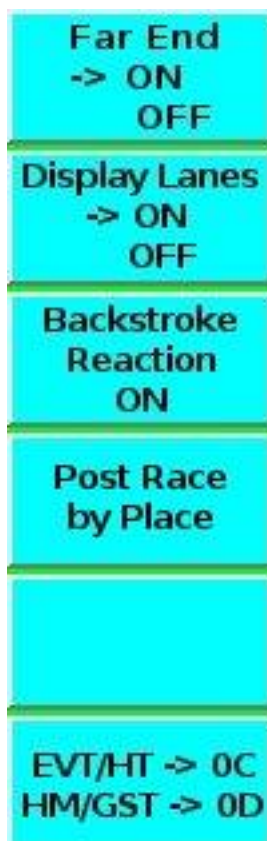

Figure 4-F Quick Options Softkey Menu

### **Far End**

If using far end touchpads to record split times, use this softkey to turn the touch pads on and off.

### **Display Lanes**

**Function:** Displays current race information on-screen. This includes lane numbers, places, split and final times, backup times, backup button status and relay judging times.

**Operation:** Press this softkey to toggle the display of current race information on-screen.

### **Backstroke Reaction**

This option will only be available if option **8** in the **Hardware** softkey menu (located in *Setups*) is selected. Allows you to use or not use start reaction times for backstroke events. This provides the same function as option **9** in the **Hardware** softkey menu.

### **Post Race by Place**

Pressing this button will repost the previous race in place order, allowing you to run a race in lane order and then immediately repost it on the scoreboard in place order.

## EVT/HT and HM/GST

**Function:** Allows the user to toggle between displaying current event/heat and home/guest scores on a single line of scoreboard of a 6-digit LED scoreboard that is assigned as either 0C or 0D.

**Operation:** Pressing this button assigns the 0C and 0D designation to either event/heat or home/guest, and serves to toggle between the two displays on a line of scoreboard assigned to 0C or 0D.

## Scoreboard



### Summary

This softkey provides access to special scoreboard control and display features for single and multi-line fixed-digit scoreboards.

### Operation

Press this softkey to display the Scoreboard softkey menu.

### Step Data

Sequences again through the results of the last race. This key is active only if you are using a single-line scoreboard. It displays the data when all lanes are finished and **Reset** has NOT been pressed.

### Clear Lanes

**Function:** Clears all place and time data on each lane module. The next start returns the scoreboard to normal display status.

**Operation:** Press this softkey to clear all of the time and place data from all active lanes on multi-line scoreboards. The lane number display is not cleared. Pressing **Scoreboard On** or the next start returns the scoreboard to normal display status. You might do this just before the Championship Final in a large meet for aesthetic appeal.

### Scoreboard Blank

**Function:** Pressed once, this softkey blanks the scoreboard and displays the time-of-day. Pressed again and this key blanks the entire scoreboard.

**Operation:** Press this softkey to blank the scoreboard and display the time-of-day on channels 03, 0F and 16. Press again for a **TOTAL BLANK** of all lines of the scoreboard. Press the *Scoreboard On* softkey to return the scoreboard to normal display status.

### **Scoreboard On**

Press this softkey to return the scoreboard to normal display status after pressing the *Clear Lanes* or *Scoreboard Blank* softkeys

### **Scoreboard On/Blank**

If you have selected option 4 in the Scoreboard Setups menu to use half as many scoreboard lines as you have active pool lanes, the Scoreboard On softkey changes to Scoreboard On/Blank, combining the features of these two softkeys. The second softkey on the Scoreboard softkey menu now allows you to display race results for the alternate set of lanes.

### **Team Scores**

**Function:** Allows the user to enter and display scores for up to 4 teams on various scoreboard modules. See page 16 or Appendix E, beginning on page 81, for options.

**Operation:** Press the softkey labeled with the appropriate team and enter the current score. Teams available are Home, Guest 1, Guest 2 and Guest 3. You must keep track of team scores manually. Select the team whose score you wish to enter. Type the appropriate score for that team and either press *Enter* or change to another team. Do the same for each team. The team scores are immediately displayed on the scoreboard. Press *Quit* instead of *Enter* only if you do not want to display new team scores.

### **Record Time**

**Function:** Allows entry of the record time for the current event.

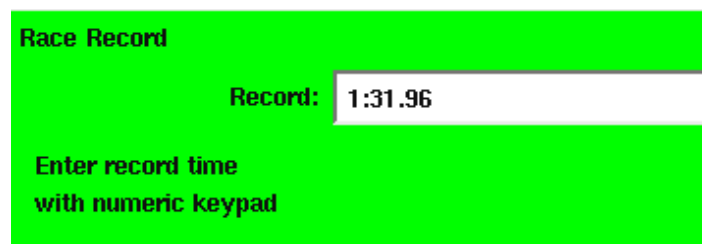
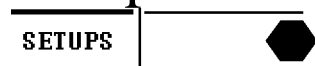

Figure 4-G Record Time Prompt

**Operation:** Press this softkey, type in the record time for the current event using the numeric keypad as shown in Figure 4-G, and press *enter*. The time entered is displayed on the Record Time scoreboard module (0B). The record time entered on this screen will also be saved with the event sequence, so that when you come back to the event, the record time will be the one previously entered. Press *quit* to exit without displaying a new record time.

# Setups



## Summary

The *Setups* softkey provides access to features that allow you to customize the Swimming software. With the exception of *Time/Date* and *Event Sequence*, setup changes are made permanent only if you press the Save *Setups* softkey after making changes. Otherwise, setup changes apply to the current session only and are lost when you exit the Swimming program. Notice the race information displayed in condensed form at the bottom of the display screen. Pressing *Setups* does not interfere with race timing, but as a general rule, setup changes should only be made when the Swimming software is in *reset* state. Press *quit* to leave Setups.

## Setups Softkey Menu

### Summary

Three softkeys are active from the main Setups display screen: *Up*, *Down* and *Save Setups*. Press the *Up* or *Down* softkey to move the arrow pointer to the desired setup option. If you want setup changes to be permanent, press the *Save Setups* softkey to save. The *Restore Defaults* softkey will restore all the settings to the system default options. Use the numeric keypad to select a specific setup option.

### Start/Finish

**Function:** Depending on your pool and what type of meet you are running, even and odd length races can start from either the near or far end of the pool. An odd length race would be a 50M race in a 50M pool. An even length race would be a 100M race in a 50M pool. We ask where you will start the race so that the timer can figure out, by counting lengths, where each race will finish. This allows the System 6 to only accept finishes from the correct end.

This feature also allows you to configure finish parameters to match your hardware setup. The Swimming system uses either touchpads or buttons for primary finish. The times produced by touchpad finish are extremely accurate. Alternatively, each lane can have up to three finish buttons. If three buttons are used, the finish time is the median of the three. If two buttons are used, the finish time is the average of the two. Button finish times are less accurate because of human reaction time. Refer to the discussion of Timing Corrections earlier in this chapter (page 27) for more information on human reaction time.

If touchpads are the primary finish system, up to three buttons per lane can be used to provide backup finish times.

## Options:

**Start End:** Press *1* to select where to start races with an even number of lengths. Press *2* to select where to start races with an odd number of lengths. In each case, the options are near end or far end, and pressing the number associated with each toggles between the options.

**Clear Lanes Automatically:** Press *3* to choose between clearing and not clearing all of the time and place information for the lanes automatically when the event or heat is changed after a race. This allows the scoreboard to be clear for the start of the next race. This is a feature used most often for championship level meets.

Option *4* toggles between showing and not showing start reaction times on the scoreboard. In order for this option to work, you must have a relay judging platform installed. You must also have option *8* activated in the **Hardware Setup** menu (page 45). This time will only be displayed for the amount equal to the pad delay settings in the timing menu (page 45).

Option *5* allows you to select the primary finish method for the near end of the pool. Option *6* allows you set the far end. If you have a Pad finish the timer will always look for buttons as a backup, and if you have a Button finish there is no other timer option for backup. These are toggle functions and will switch back and forth between the available choices.

Press *7* to make the time on the scoreboard blink in the event of a record being broken. You must have a record time stored in the system to operate this feature.

Option *8* toggles between posting and not posting intermediate place status (splits from the touchpads) on scoreboard.

## Hardware

**Function:** Allows you to configure your System 6 internal speaker volume, screen backlight intensity, whether or not to allow Setup information to be downloaded from a PC, and relay judging method and details. Far end splits, start reaction times and LED Numeric Scoreboard intensity are also controlled from this section. Generally, the speaker volume should be set to an audible level.

It is very important that you set the proper relay judging method. Electrically the buttons and Relay Judging Platform (RJP) are very different.

**Operation:** Press *1* to set the System 6 internal speaker volume. In the prompt box, type *0* to turn the speaker off, *1* for low, *2* for medium or *3* for highest volume and press *enter*.

Press *2* to select the System 6 screen backlight intensity. In the prompt box, type a number between 1 and 9, with 1 being the lowest intensity. Press *enter* to activate your selection.

Press *3* to enable the Allow Remote Setup option. Pressing *3* toggles the setting between Remote Setup allowed and Remote Setup NOT allowed. When allowed, this option lets you to edit some



setup information on a PC using meet management software and then upload that information to your System 6 through com port 1. This is especially useful for setting up event sequences. If remote setup is not allowed, you cannot change the event sequence from Meet Management.

Options **4** and **5** allow you to select relay judging using either Buttons or Platforms at the near and far ends of the pool. Both options toggle between buttons and platforms; option **4** sets the near end, and option **5** sets the far end.

Option **6** allows you to set the relay judging interval during which the System 6 will consider a relay exchange legitimate. This is the window of time between the incoming swimmer's touch and the next swimmer's departure. Press **6** then type the relay judging interval with the numeric keypad, and press **Enter**. Type a leading zero to get a decimal point. A good window is .75 seconds for most meets; you might want to go to 1 second for young swimmers.

Option **7** allows you to turn on *Far End Splits* if you have touch pads at the far end of the pool. This option can also be controlled from the *Quick Options* menu (see page 39)

Press **8** to use start reaction times for events starting from the blocks and **9** to use reaction times for backstroke events.

Option **0** changes the intensity of numeric LED scoreboards. In the prompt box, press a number between 1 and 8 to change the scoreboard intensity, with 8 being the brightest.

## **Timing**

**Function:** Controls variable timing functions.

## **Operation**

**Timing Precision:** Press **1** to toggle between 1.0, 0.1, 0.01, and 0.001 second timing precision. The timing precision option selects the number of decimal places to which times are accurate. Almost all ruling bodies for Swimming specify .01 as the timing accuracy for electronic timing.

**Automatic Backup Time Adjustment:** When turned ON this will do the calculations, as specified by USA Swimming, to the backup buttons to produce the official backup time (page 27). Press **2** to choose whether or not to use automatic backup time adjustment.

**Pad Split Delay Time:** Options **3** and **4** allow you to set the pad split delay time. Use the numeric keypad to type the delay time and press **enter**. Pad split delay time allows you to set the length of time the touchpads are inoperative after a touch, allowing relay swimmers to get out of the pool without triggering a pad touch. The recommended delay time for both near- and far-end pads is 15 seconds. You might want to increase this for relays in a long course pool.

**Time Warning Messages:** Press **5** to toggle between displaying and not displaying time warning messages. This feature is designed to help the timer operator detect missed or defective touchpads. As the race progresses, the System 6 continuously compares the running time to the

average split time for each lane. If, based on a factor of the previous splits, the current lap seems to be taking too long the System 6 will notify the operator that there may be a missed touchpad in a given lane. This feature does not affect the timing of the race; it simply serves as a notification to assist the operator.

**Pad Delay at Start:** Press **6** to set pad delay at start, press **C/E**, type the seconds of delay time, and press **enter**. The pad delay at start time allows you to set the time all pads are inoperative after the start of a race. This is done so that backstroke swimmers do not trigger their pad at the start of a race. This number also controls how long start reaction time will stay on the scoreboard at the beginning of each race (Start reaction is a feature that requires Relay Judging Platforms).

**Length Count Display:** Press **7** to toggle whether the lengths count up or down on the scoreboard, press **8** to choose the same for the screen.

**Show ----- on DQ:** Press **9** to toggle between displaying a series of dashes (-----) or the time in the event of a disqualification. This option affects the scoreboard display only. The final time will always be shown on the display screen on the System 6.

**Pad to Backup Comparison Interval:** This option allows you to set the acceptable amount of time between the swimmer touching the touchpad and the referee pressing the backup button. If the time falls outside the acceptable window, the backup time will be marked with an asterisk and a warning message will be displayed. The standard time is 0.31 seconds. Press **0** to enter your preferred time.

## **Pool**

**Function:** Controls the setup configuration information for your pool, including the length of the pool, the unit of measurement (yards or meters), the number of lanes in the pool, the number of lanes used for this meet, and mapping of those lanes and how those lanes are numbered. In most installations, the touchpad/backup button cables are set up with lane 1 closest to the timer. If, however, lane 1 is at the far end of the cable, reverse the lane order with this setup to properly configure the Swimming software.

**Operation:** Proper timer configuration requires that you enter the pool length on this setup. For example, a 100 yard race in a 25 yard pool is 4 lengths, or 2 pad touches at the near end. A 100 meter race in a 50 meter pool is 2 lengths, or one touch at the near end to finish.

Press **1** to set lane mapping. In the lane mapping submenu, press **1** to use normal lane mapping, **2** to reverse the lane mapping, **3** to shift the lanes up and **4** to shift the lanes down. The display on the right side of the screen shows the way the lanes are numbered for the race compared with (a) the actual physical pool lanes if you have in-deck wiring or (b) the markings of the cable harness.

**Note:** The scoreboard operation of the System6 is optimized for Normal lane mapping. If any other lane mapping is selected, a slight delay may occur when split and finish times are posted to the scoreboard. This is normal and only affects the speed of scoreboard posting; all race timing remains accurate regardless of lane mapping.

Press **2**, type the number of lanes in the pool with the numeric keypad and press **Enter**.

Press **3**, type the number of lanes being used with the numeric keypad and press **Enter**.

Press **4**, type the pool length with the numeric keypad and press **Enter**.

Press **5** to toggle between yards and meters.

Press **6** to toggle between 0 and 1 for the number of the first lane. This option should always be set to 1 unless you are following the FINA rule for 10-lane pools.

## **Scoreboard**

This menu controls the parameters that affect modular fixed digit scoreboards (CTS LED and light-reflective).

**Option 1 Self Test** checks all scoreboard digit segments by running a test pattern on the scoreboard. You can stop the test pattern display by pressing any key.

### **Option 2 Define Module(s)**

**Function:** Allows you to send one module's data to a different module. Carefully read the Scoreboard section in chapter 2 before attempting to redefine any scoreboard modules. In the Swimming software all scoreboard module logical addresses default to the physical addresses. For example, the physical switch setting for the scoreboard module displaying data for lane 1 is 01, so the logical address is also 01. If you want the lane 1 (01) scoreboard module to display lane 10's data set its logical address in this setup to 0A. On the module definition window, as shown in Figure 4-G, the physical addresses appear on the left, the redefined logical addresses on the right.

**Operation:** Press **2** to display or change scoreboard module definitions, press the **Up** or **Down** softkey until the arrow points at the desired physical address as shown in Figure 4-H, then press **1** and type the two-digit logical address in the prompt box with the numeric keypad (and with the softkey menu if a letter is required, as in 0A). Press **2** to display module definitions on the scoreboard. Press **2** again to clear definitions on the scoreboard.

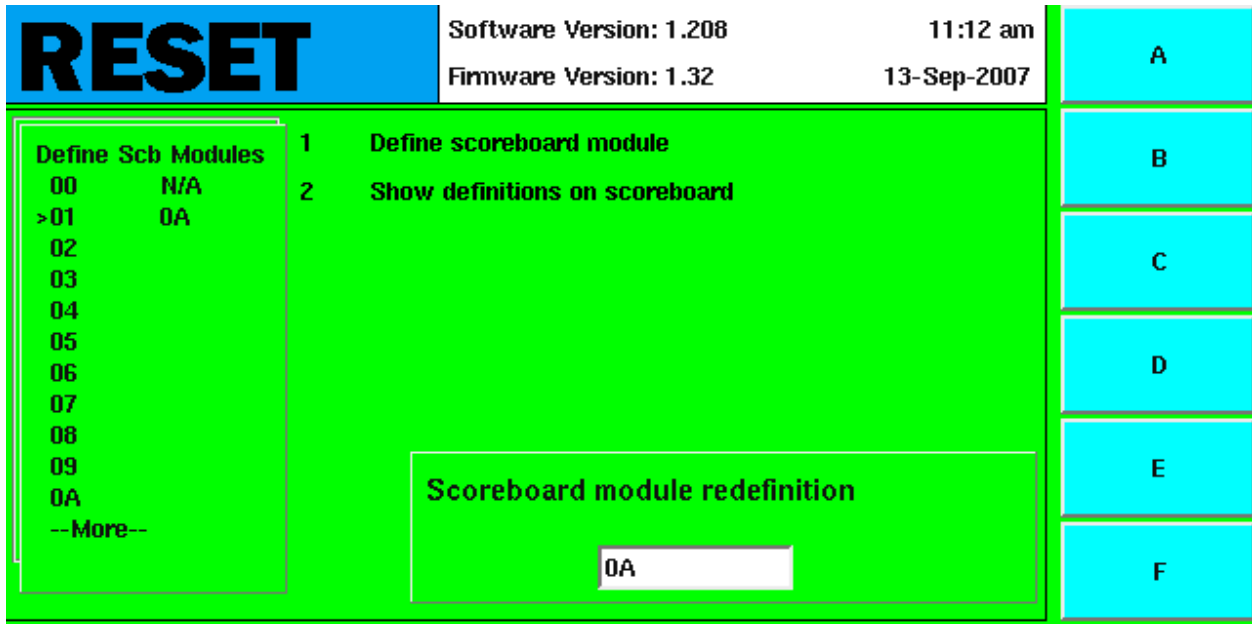

Figure 4-H Scoreboard Module Definition Window

Note: For scoreboard module numbers and sample displays, see Chapter 2 & Appendix D.

### Option 3 Blank Scoreboard Module

Allows you to blank unused scoreboard modules. Press **3** to select **Blank Module(s)**. Press the **Up** or **Down** softkey until the arrow points at the desired module and press **I** to blank, as shown in Figure 4-I. Repeat the procedure to un-blank a blanked module.

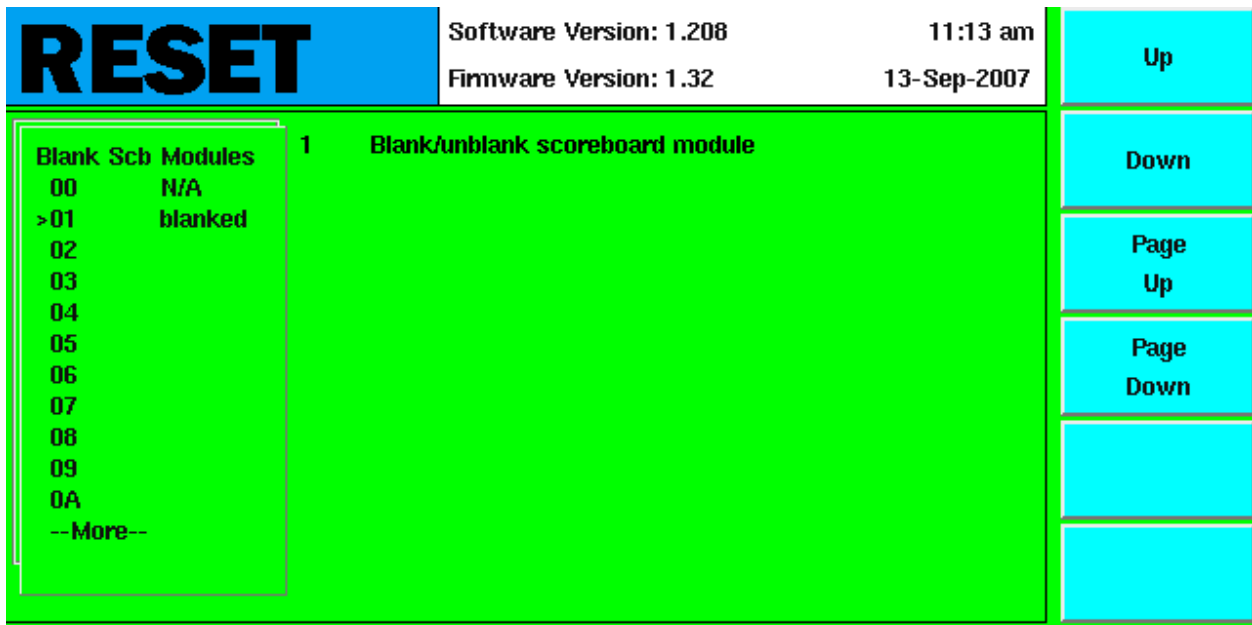

Figure 4-I Blank Scoreboard Module Window

## Option 4 Number of Scoreboard Lines

**Function:** Allows you to designate how many lines of scoreboard will be used. Normally you would display 6 lanes of data on 6 lines of scoreboard. Option 4 allows you to rotate many lanes of data through a limited number of scoreboard modules. To set this option for fewer modules than you have lanes just press the #4 on the numeric keypad. Keep hitting the #4 key until the screen number matches the actual number of scoreboard lines that you have. If you have a 6 lane pool but only 3 lines of scoreboard, you should set this option to “3-Line Scoreboard.” This will cause the board to display data from lanes 1-3 on the board. The timer will then automatically switch the display to lanes 4-6, and continually cycle between the two. The length of time that the data will be shown will be the number of seconds that you have defined below in option 6.

**Operation:** Press 4 to change the number of lines of scoreboard that you have set to display swimming lane information. For example, if you have an 8 lane pool, but only 4 lines of scoreboard, you can press this option until it reads “4-Line Scoreboard” and the scoreboard will continuously cycle between showing lanes 1-4 and lanes 5-8. Options 5, 6, and 7

**Function:** Options 5, 6 and 7 apply **ONLY** to scoreboards designated as 0F. Ordinarily, a single-line scoreboard displays the race results by place at the end of the race and then displays the programmed sequence. Feature (5) allows you to set the number of times this information is displayed. (6) The sequence time for each item. Select the time in seconds each item in the sequence is displayed. This setup also sets the minimum time that each result is displayed as the swimmers finish. (7) Allows you to create a sequence list which defines exactly which information gets displayed on this module. This option also allows you to use a multiple line scoreboard to display different information sequentially rotating through on a fixed interval. For example, the same board could display Time of Day and Team Scores in an alternating manner. Please see page 15 for more details.

**Operation:** Press 5 to enter the number of times a single-line scoreboard is to step through the results of the last race--type the desired number and press **Enter**.

Press 6 to display the single-line scoreboard sequence time prompt box. Type the time in seconds that each item is to be displayed on a single-line scoreboard and press **Enter**.

Press 7 to define a single-line scoreboard sequence list. Choose the item to be added to the sequence on a single-line scoreboard. Choices are:

- Record
- Event/heat
- Team scores
- Place pick
- Place order
- Team scores for several different team combinations
- Time of day

Press the *Choices Up* or *Choices Down* softkeys until the desired item is highlighted and press *INSERT* to add the selection to the list. Edit the list by pressing the *List Up* or *List Down* softkeys and press *DELETE* to remove a selection from the list. Press *quit* to exit this window.

### **Option 8**

Allows you to choose the way race results sent to the scoreboard are sorted, either by lane order or by place order. Press 8 to cycle among displaying results in place order, lane order or lane order with separate running time.

Place order displays race results on the scoreboard in ascending place order, with 1st place at the top of the scoreboard.

Lane order displays race results on the scoreboard in ascending lane order, with the first lane always at the top of the scoreboard.

Lane order with separate running time also displays race results on the scoreboard in ascending lane order with the first lane at the top; the difference is that the running time is not displayed on the lane modules. Instead, it is displayed only on module 12 until the last swimmer in the race finishes.

Both *Lane* and *Place* order will display the results on the scoreboard as LANE PLACE TIME from left to right across the board.

### **Option 9**

**Function:** Lets you choose whether splits displayed on the scoreboard are cumulative or subtractive. If you choose this option running time will display on the board showing total time, splits will show as **subtracted** and **FINAL TIME** will show as the true final time.

**Operation:** Press 9 to choose whether to display cumulative splits or subtractive splits on the scoreboard. If you choose **SUBTRACTED** running time will display on the board showing total time, splits will show as **subtracted** and **FINAL TIME** will show as the true final time.

### **Option 0**

Press 0 to choose whether to emulate a ten-lane scoreboard. If you choose to emulate a ten-lane scoreboard, the lanes and places for numbers greater than or equal to 10 will be displayed numerically (i.e., 10 = 0, 11 = 1, 12 = 2). If you choose to not emulate a ten-lane scoreboard, they will be displayed as letters (i.e., 10 = A, 11 = b, 12 = C).

### **Printer**

This setup allows you to customize the sequence of information printed when you press *Store/Print*. It also allows you to configure the Swimming software to use your printer. The Swimming system can use any printer that has a standard parallel interface, can take an ASCII stream of data and print a minimum of 80 characters per line. You can also use many USB printers; see the Sport Loader manual for details.

### Option 1

Press **1** to define the print sequence for the **Store/Print** key. Highlight the desired print item with the **Choices Up** and **Choices Down** softkeys and press **INSERT** to add that item to the list. Edit the list by pressing the **List Up** or **List Down** softkeys and press **DELETE** to remove a selection from the list. The best way to organize the print format is to end it with a **form feed** so that after each printout is complete, the paper advances to the top of the next page. **Some printers will hold your printout inside until it receives a form feed command or completely finishes a full page of printing.** Press **Quit** to leave this screen.

### Option 2

Press **2** to view or enter the sponsor's message. To clear the existing message, press **C/E**. Create the message by highlighting the desired character with the **Up**, **Down** or **Jump Forward** softkey and pressing enter to select it. Press **Right** to move to the next space to the right. Repeat the process until the message is complete. The **Jump Forward** softkey jumps down 10 characters to allow you to move more quickly through the list of characters. Use the **Left**, **Right** and **Delete** softkeys to edit the message. Press **Quit** to exit.

### Option 3

Pressing **3** toggles between **ALWAYS PRINT** and **DO NOT ALWAYS PRINT** on **Store/Print Key**. **ALWAYS PRINT** will cause race results to be immediately printed when you press Store/Print even if there are timing problems. You can, of course, always print another set of results with the print key. Refer to page 27 for more information on timing problems.

### Option 4

Press **4** to define printer control codes for your printer. Refer to your printer's manual for the specific codes required. To enter printer control codes, have your printer manual open to the page(s) that show the control codes for pica, elite and condensed print modes. Highlight the printer functions you want to define with the **Choices Up** or **Choices Down** softkeys. Using the keypad, type the ACSII value and press the **INSERT** softkey to add that ASCII value to the code string. Build the control list exactly as it is shown in your printer's manual. Use the **Left**, **Right** and **Delete** softkeys to edit the control code sequence. Press **quit** when you are done. You do not need to enter any items that you will not be using. If you used a printer with the System 5, the printer control codes will be the same for the System 6. The most common printer codes are listed on page 74.

### Option 5

Press **5** to cycle through pica (6 lanes), elite (8 lanes), condensed (10 lanes) or super condensed (12 lanes) type size needed on your race printouts.

## Option 6

Press **6** to toggle between 6 and 8 lines of type per vertical inch. 8 lines per inch is the default setting. 6 lines per inch will give you up to 64 lines of print on a page while 8 lines per inch will give you up to 84 lines of print on a page.

## Option 7

Press **7** to choose the type of printer you will be using. Use this option to select your printer if it is listed (Citizen, HP, IBM, Okidata, Other). If we know your printer's codes we will automatically load them. If you select **Other** you will have to manually enter your printer's codes in option **4**.

## Option 8

Press **8** to choose space for hours or minutes in printouts. This controls how wide the data fields for split times are. For nearly all meets, you can leave this set to "Space for Minutes." If you are using the System 6 for long distance events, change this option to "Space for Hours" to allow for extra room to accommodate hours.

## Option 9

Press **9** to choose to show or not show event sequence title in header. . If enabled, the title of the event sequence will print at the top of every printout. This allows you to print the meet name on each printout without using the Sponsor Message.

## Sample Printouts

These sample printouts show some of the possible print combinations.

```
====> RACE SUMMARY <=====> Race [0003] <=====  
Monday 17-Sep-07 10:23:52 am  
200 Boys Medley Relay  
Event: 1 Heat: 3  
  
----- BY LANE -----          ----- BY PLACE -----  
Lane Place Time Backup          Place Lane Time Backup  
1 1 1:35.94  
2 2 1:36.68  
3 4 1:38.14  
4 3 1:37.63  
5 5 1:38.62  
6 6 1:39.10  
7 7 1:39.53  
8 8 1:39.95  
  
Lane 1 Lane 2 Lane 3 Lane 4 Lane 5 Lane 6 Lane 7 Lane 8  
Backup 1:35.93 1:36.69 1:38.13 1:37.62 1:38.63 1:39.09 1:39.54 1:39.92  
Btn. A 1:35.78 1:36.57 1:38.01 1:37.47 1:38.50 1:38.95 1:39.41 1:39.79  
Btn. B 1:35.80 1:36.55 1:38.00 1:37.49 1:38.51 1:38.96 1:39.36 1:39.79  
Btn. C 1:35.83 1:36.56 1:38.00 1:37.50 1:38.51 1:38.97 1:39.41 1:39.78  
React  
Average Pad to Backup Delta time: -.13  
====> Sys6 v1.208 <=====> Colorado Time System 6 <=====
```

Figure 4-J Race Results by Lane and Place



```

=====> SPLITS_SUMMARY <=====> Race [0003] <=====>
Monday 17-Sep-07 10:23:52 am

200 Boys Medley Relay
Event: 1 Heat: 3
Lane 1 Lane 2 Lane 3 Lane 4 Lane 5 Lane 6 Lane 7 Lane 8
50 Y 21.59 20.08 18.79 17.42 23.97 22.79 25.23 25.99
100 Y 30.98 30.72 31.23 34.44 29.68 31.48 29.69 30.05
150 Y 23.83 24.26 22.02 19.39 19.66 20.10 22.71 22.22
200 Y 19.54 21.62 26.10 26.38 25.31 24.73 21.90 21.69
---
50 Y 21.59 20.08 18.79 17.42 23.97 22.79 25.23 25.99
100 Y 52.57 50.80 50.02 51.86 53.65 54.27 54.92 56.04
150 Y 1:16.40 1:15.06 1:12.04 1:11.25 1:13.31 1:14.37 1:17.63 1:18.26
200 Y 1:35.94 1:36.68 1:38.14 1:37.63 1:38.62 1:39.10 1:39.53 1:39.95
---
Place ( 1 ) ( 2 ) ( 4 ) ( 3 ) ( 5 ) ( 6 ) ( 7 ) ( 8 )
Finish 1:35.94 1:36.68 1:38.14 1:37.63 1:38.62 1:39.10 1:39.53 1:39.95
=====> Sys6 v1.208 <=====> Colorado Time System 6 <=====>

```

Figure 4-K Splits Summary Printout

```

=====> Relay Exchange Summary <=====> Race [0003] <=====>
Monday 17-Sep-07 10:23:52 am

200 Boys Medley Relay
Event: 1 Heat: 3
Lane 1 Lane 2 Lane 3 Lane 4 Lane 5 Lane 6 Lane 7 Lane 8
50 Y .15 .01 .05 .05 .13 .12 .20 .18
100 Y .17 .11 .07 .19 .19 .19 .06 .15
150 Y -.02 .16 .17 .08 .19 .19 .08 .06
Exch. EARLY |OK OK OK OK OK OK OK
=====> Sys6 v1.208 <=====> Colorado Time System 6 <=====>

```

Figure 4-L Relay Exchange Summary

```

=====> Race History <=====> Race [0003] <=====>
Monday 17-Sep-07 10:23:52am

200 Boys Medley Relay
Event: 1 Heat: 3
|------( Lane Number
| |------( Lengths
| | |---( Time
4) 2 17.42 4) LATE .05 3) 2 18.79 3) LATE .05 2) 2 20.08
2) LATE .01 1) 2 21.59 1) LATE .15 6) 2 22.79 5) 2 23.97
7) 2 25.23 7) LATE .20 8) 2 25.99 8) LATE .18 3) 4 50.02
3) LATE .07 3) LATE .07 2) 4 50.80 2) LATE .11 4) 4 51.86
4) LATE .19 1) 4 52.57 1) LATE .17 5) 4 53.65 5) LATE .13
6) 4 54.27 6) LATE .12 7) 4 54.92 7) LATE .06 8) 4 56.04
8) LATE .15 4) 6 1:11.25 4) LATE .08 3) 6 1:12.04 3) LATE .17
5) 6 1:13.31 5) LATE .19 6) 6 1:14.37 6) LATE .19 5) 6 1:15.06
7) LATE .16 1) 6 1:16.40 1) EARLY -.02 7) 6 1:17.63 7) LATE .08
8) 6 1:18.26 8) LATE .06 1) 8 1:35.94 2) 8 1:36.68 4) 8 1:37.63
3) 8 1:38.14 5) 8 1:38.62 6) 8 1:39.10 7) 8 1:39.53 8) 8 1:39.95
=====> Sys6 v1.208 <=====> Colorado Time System 6 <=====>

```

Figure 4-M Race History

## Event Sequence

**Function:** This setup allows you to program a sequence of swimming events for different types of meets. The race gender and distance are attached to the event number so that each time you press *Next Event* the race gender, distance and name are updated. After programming, select the desired meet type to sequence events automatically.

Select option *I (None)* to enter race distance manually at the start of each event. Options 2-7 already have a pre-programmed event sequence. You can use these sequences as is or reprogram your own sequences for any of these events. Options 8 and 9 are user-defined event sequences, which can be programmed from scratch to fit your needs.

<b>RESET</b>		Software Version: 1.208	9:24 am	Up					
		Firmware Version: 1.32	14-Sep-2007						
◆ Start/Finish	1	None		Down					
◆ Hardware	2	Boys High School							
◆ Timing	3	Girls High School							
◆ Pool	4	Boys/Girls H. S.							
◆ Scoreboard	5	NCAA 13 Event Prog.		Save					
◆ Printer	6	NCAA 15 Event Prog.		Setup					
◆ Event Sequence	7	NCAA 16 Event Prog.		Sequence					
◆ Set Date/Time	8	User Defined 1		Name					
◆ Wireless	9	User Defined 2		Restore					
	0	View/Edit Selected Sequence		Defaults					
Event:	1	200 Boys Medley Relay							
Heat:	1	Race #	Lengths:	8					
	1	2	3	4	5	6	7	8	

Figure 4-N Event Sequence Window

**Operation:** To program an event sequence, press the number corresponding to the desired meet type, then press *0* to view or edit the selected sequence. The events already defined, if any, are displayed, and you can insert or delete events.

The Define Event softkey menu, shown in Figure 4-O, allows you to select the event number to insert. Use the *Up*, *Down*, *Page Up* or *Page Down* keys to move the arrow to the event number you want to program, and press *INSERT Event*.



Figure 4-O Define Event Softkey Menu

Enter the event distance using the event keys on the lower keyboard (See page 34). Press the appropriate softkeys for Swimmer type (gender), age group, event type (stroke) and bracket (session) to build the race description, as shown in Figures 4-P and 4-Q. Each softkey category contains a menu from which you can select the desired item, as shown in Figure 4-Q. To select an item within a category, press the *Up* or *Down* softkeys until the arrow points at the desired item and press *Enter*. Event sequences that are entered or downloaded onto the System 6 are saved automatically.

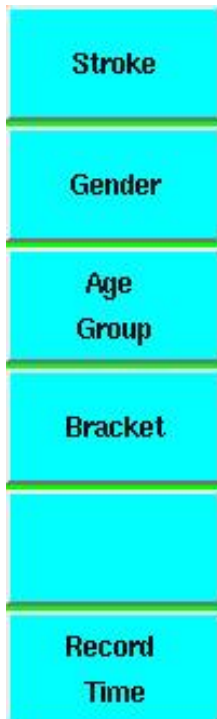

Figure 4-P Event Type Softkey Menu

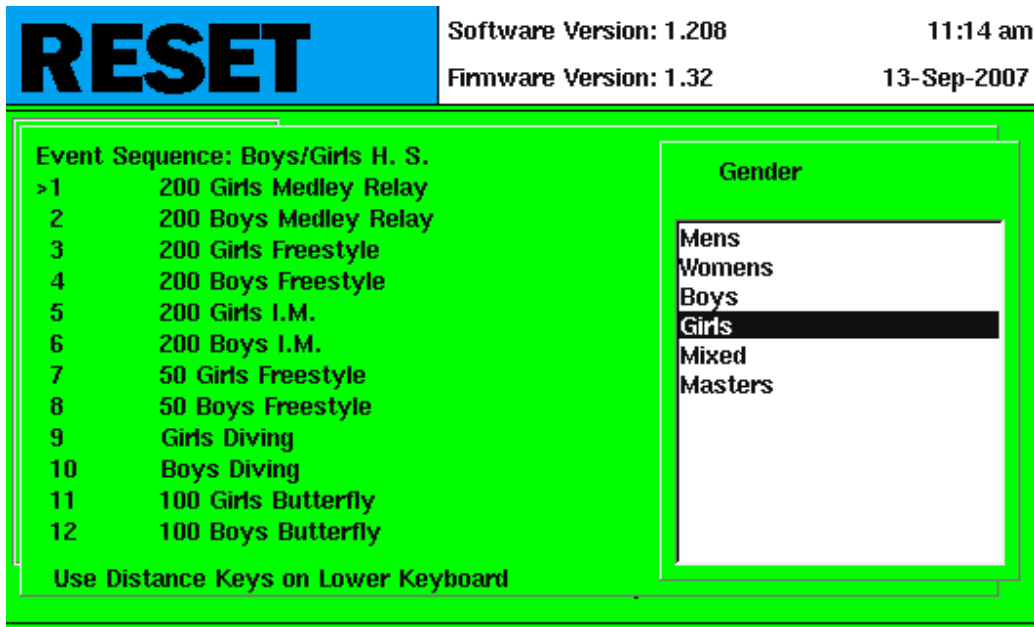

Figure 4-Q Race Description Window

When finished entering the race description, press **Enter** to complete the entry. Press the **Up** or **Down** softkey to select the next event number to program and repeat the process. To delete an event, position the cursor on the desired line using the **Up** or **Down** softkey and press the **Delete Event** softkey. To insert a new event between events already defined, position the cursor on the event number you want to add and press the **Insert Event** softkey. All lines below the selected

event are pushed down one position. The selected event line is blank and ready to be programmed.

When done programming events, press **Quit**. Event Sequence is automatically saved so you do not need to press **Save Setups** to save the changes just made.

To run a meet using a programmed event sequence, press the number corresponding to the desired meet type. To operate the Swimming software without an event sequence, press **1** which selects no event sequence.

## Time/Date

The System 6 has an internal clock, which it uses to stamp the time and date on races and meets. Press **1** to set the time of day. Type the correct time (using HHMMSS format) in the prompt box using the numeric keypad and press **enter**. Follow the same procedure to set the date (using MMDDYY format). Pressing **3** toggles between 12-hour and 24-hour time display format. The time and date are stored in permanent memory as soon as you press **Enter**; it is not necessary to press **Save Setups** to save a new time and date.

## Wireless

If you are sending your scoreboard information via a wireless adapter, this menu will allow you to change the settings. Option **1** will display the channel that the wireless adapter is currently set to on the scoreboard; in order for the scoreboard to display wireless data, the channels on the transmitting and receiving wireless adapters must be the same. Option **2** will display the firmware version of the wireless adapter on the scoreboard. Options **3** and **4** allow you to change the channel settings for the transmitting and receiving wireless adapters. If you change the channel settings through the System 6, it will override any channel settings set with the DIP switches on the wireless adapters.

# Stored Data



## Summary

The **Stored Data** softkey provides access to race data from current and previous meets. Swimming's memory capacity is thousands of splits. When you press **Store/Print** after a race, that race is added to the top of the list of races in memory. If the capacity of memory has been reached, the oldest race in memory is automatically deleted to make room for the new race. If you do not wish for your data to be deleted, you can save it to a disk by pressing the **Disk** softkey in the sport loader menu. For the purposes of Stored Data, a "meet" begins when turn the timer on or when you press the **Create New Meet** button.

Pressing the **Stored Data** softkey displays the results of the last race saved. The race distance and stroke, race number, event and heat numbers, race date and time, race print status, lane, place,

pad and backup times, calculated backup times, and RJP exchange times (if RJP's are installed) are displayed on the screen.

### **Softkey options**

There are three screens of softkeys in the Stored Data menu. On all three screens, ***Print Race*** and ***More*** remain constant as the bottom two softkeys. They are described first below, followed by all of the other options.

### **Print Race**

**Function:** Allows you to print the results of the race currently displayed. This selection always appears as the second to last choice, even when ***More*** is pressed to cycle through the options available on the top four softkeys.

**Operation:** Press this key to display the ***Print*** softkey menu. Press the appropriate softkeys to build a printout format. Refer to the discussion of the Print softkey earlier in this chapter on page 38 for more detailed instructions.

### **More**

**Function:** Cycles through the three menus in the stored data screen. Each menu has four options. The additional softkey functions are explained below.

### **Next Race**

**Function:** Displays the results of the next race number in the current meet. When the most recently stored race is displayed, pressing the softkey resets the display to the bottom of the list, displaying the oldest race in the current meet.

### **Previous Race**

**Function:** Displays the results of the previous race number in the current meet. When the oldest race in the meet is displayed, pressing this softkey resets the display to the top of the list, displaying results from the most recently stored race.

### **Next Event**

**Function:** Displays the results of the next event number in the current meet.

### **Previous Event**

**Function:** Displays the results of the previous event number in the current meet.

## **Print Yes/No**

**Function:** Used in conjunction with the *Print Meet* softkey. Each race in memory is automatically set to print when you press *Print Meet*, but it is sometimes desirable not to print every race in a meet. For example, if a race was used to test the touchpads and then stored, it should not be printed.

**Operation:** To prevent the results of a given race from being printed, display that race on the screen and press the *Print Yes/No* softkey. This softkey toggles between print status of the displayed race on and off.

## **False Start**

**Function:** Allows you to label a race in memory a false start. False start races are not printed on any printout.

**Operation:** Display the desired race on the screen and press this softkey to mark it as a false start. This softkey toggles false start on and off. This should **ONLY** be used on races that were called back because of a FALSE START. Many of governing bodies do not charge the swimmer with a FALSE START until the race is over. In this case the race is GOOD and only the individual swimmer should be charged with the FALSE START, **not the heat**.

## **Edit/DQ**

**Function:** Allows you to edit the results of the past races stored in memory if necessary, to correct an error.

**Operation:** Display the desired race on the screen and press this softkey to access the editing features. Press the *Edit Time* softkey and type the lane number you want to edit. Select the correct backup time from the softkey menu or press *C/E* and type a stopwatch time. The Swimming software calculates any changes in finish order based on the new time.

To disqualify a swimmer, display the desired race on the screen and press the *Edit/DQ* softkey. Press the *DQ* softkey, type the appropriate lane number and press *enter*. Repeat the procedure to *un-DQ* a disqualified swimmer.

The *NP* button allows you to designate a swimmer with a “Non-Participant.” To mark a swimmer “NP,” press the *NP* softkey, type the appropriate lane number and press *enter*.

## **Scoreboard Post**

**Function:** Allows you to post the results of the currently selected race.

**Operation:** Press this softkey and select the desired options from the softkey menu to post the results of the currently selected race. The softkey allows you to display results by lane or by place. If the number of scoreboard lines (Option 4 in **Scoreboard**, page 49) is less than the

number of lanes to post, the results will display appropriately (i.e., 8 lanes will display on a 4 line board as 1-4 then 5-8).

### **Next Meet**

**Function:** Allows you to select the next meet stored in memory. When the most recently stored meet is displayed, pressing this softkey resets the display to the bottom of the list, displaying the oldest race in memory.

### **Previous Meet**

**Function:** Allows you to select the previous meet in the sequence in memory. When the oldest meet in memory is displayed, pressing this softkey resets the display to the top of the list, displaying results from the most recently stored meet.

### **Print Meet**

**Function:** Prints the results of all races in the current meet beginning with the race displayed on the screen to the end of the meet. Races with a print status of *no* are not printed.

**Operation:** To print an entire meet, press the *Next Race* or *Next Event* softkey until the first valid race in the meet is displayed on the screen, then press the *Print Meet* softkey. Pressing this softkey displays the *Print* softkey menu. All races are printed in the format that you enter from the menu. Press the appropriate softkeys to build a printout format. Refer to the discussion of the *Print* softkey earlier in this chapter for more detailed instructions.

## Misc



### **Pad Power On/Off**

**Function:** Turns off power to the pads until the next **start** is received.

**Operation:** This feature is used to reduce connector corrosion and extend touch pad life by removing the small amount of voltage from the touch pads. We recommend that you turn the Pad Power OFF during warmups when there are lots of hits on the pads. Power is automatically turned back on whenever the timer starts.

### **Change Sport**

**Function:** Returns the System 6 to its main menu, allowing you to change to other sport programs that you have purchased and downloaded. From the main menu, you can also run diagnostics, install new programs or updates, or shut down the system.



**Note:** To properly turn off the System 6, be sure to return to the main menu and press **Shut Down**. Then, turn off the System 6 using the power switch on the back.

Please see the description of the main menu on pages **Error! Bookmark not defined.** and 26 for more details.



Figure 4-R Misc Softkey Menu

### **Colors**

**Function:** Allows you to set the colors for your System 6 screen.

**Operation:** Press the appropriate softkey to set the background color, and softkey color. Pressing Default sets the background to Green and the softkeys to Aqua. Please note that the text will always be black, so it is wise to choose a somewhat lighter color for the background, and softkeys.

**Create New Meet** allows you to save the current meet and start a new one. When a new meet is created, all of the results are cleared from the screen and the event, heat and race numbers are all reset to 1.



# Appendix A: Maintenance

This appendix contains information to help you identify and quickly correct problems in your Swimming system without calling customer service or returning equipment to the factory unnecessarily. To use this appendix effectively, read the first six pages and perform any routine maintenance as necessary.

If a problem persists, identify the system that is not functioning properly, for example start system, finish system, scoreboard, printer, etc. Then refer to the Troubleshooting section, find the problem you are experiencing and perform the suggested remedy and/or refer to the page reference for further instructions. Try the suggested remedies **exactly as given, one at a time and in the order listed**. Be sure to record the remedies tried and their results for future reference.

## Customer Service

If the problem you are experiencing is not described in this chapter, or a problem defies solution, please call the Colorado Time Systems' Customer Service Department toll-free in the US and Canada at 800-287-0653 or at +1 970 667-1000 from all other countries.

**Caution:** *The System 6 uses low-current CMOS components that make battery operation possible. Low current CMOS is **extremely** susceptible to static electricity. Therefore, do not remove the System 6 cover. Refer **all** internal servicing to the factory. Improper servicing could seriously damage all of the sensitive components!*

## Factory Maintenance

Return the System 6 to the factory every 5 to 7 years for the following calibration and testing:

- 1) The accuracy of the timing circuitry can vary with age. The System 6 contains a high-quality crystal oscillator that is guaranteed to be accurate for five years. After five years of service, the oscillator could drift out of tolerance. To ensure accurate race timing, your System 6 should be tested at the factory after five years.
- 2) The battery mounted on the main circuit board that powers the System 6's continuous memory has a manufacturer-specified life span of 10 years. To ensure the integrity of stored data, the battery should be replaced every 5 to 7 years. Replacement of this battery **must** be performed at the factory.
- 3) The rear-panel connectors need to be inspected for corrosion and damage and replaced if necessary.

# Routine Maintenance

## Connectors

Inspect the cable connectors on the System 6 back panel every time you plug the cable harness(es) into the connector(s). Clean as necessary.

To clean cable connectors, put two or three drops of alcohol on a cotton swab (this is NOT the standard cotton swab for your ear but a cleaning cotton swab, which you can get at almost any electrical supply store, such as Radio Shack), or a folded soft pipe-cleaners used for crafts, and insert the swab into the connector. **Pull the swab straight out.** Move the swab to the next section of the connector and repeat. **Do not slide the cotton swab along the inside of the connector.** Damage to the contacts could result. Rinse the connectors with a damp cotton swab, and then dry with a dry swab using the same motion. See Figure A-2. **Never use corrosive cleaners such as steel wool or corrosive chemicals such as Lime-A-Way® to clean these connectors!**

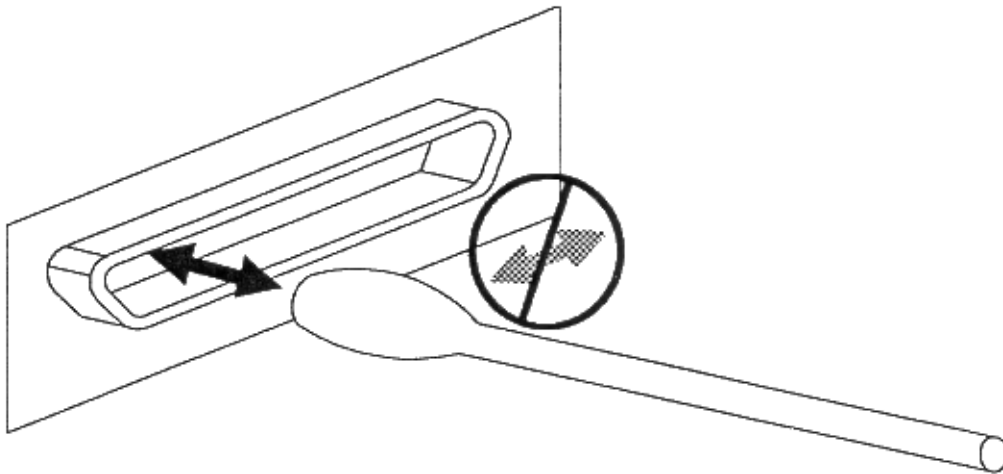

Figure A-2 Clean Data Connectors as Shown

Note: In order to reduce corrosion on the touchpad connectors, it is advised that you power off the touchpads when they are not being used.

## LCD Window

The LCD window is made of non-glare, scratch resistant plastic. Clean regularly with any good cleaner made for clear plastic and a soft cloth. **Do not** use any cleaning products that contain ammonia. **Do not under any circumstances wipe the LCD window with a dry cloth.**

## **Case**

The System 6 case is made of high-impact plastic. Use any neutral detergent to clean the case. Do not use alcohol, thinner or other solvents. These products can change the color or otherwise damage the case.

## **Keyboard Inserts**

The keyboard insert cover and upper overlay should be cleaned with a mild detergent and water solution and wiped dry with a soft cloth as needed. Install the keyboard insert carefully. Guide it into the keyboard pocket, keeping it as straight as possible.

# Cables

## **Cleaning**

Inspect all cable and in-deck connectors for corrosion before use. All connectors must be corrosion-free if your timing system is to operate properly.

To clean cable or in-deck connectors you need rubbing alcohol, silicone grease and cotton swabs. Follow the instructions below and refer to Figure A-3 for reference.

- 1) Pour a few drops of rubbing alcohol into the cable or deck plate jacks and let it sit for several minutes to dissolve corrosion.
- 2) Insert a cotton swab into the jack and use a plunging motion to clean the jack.

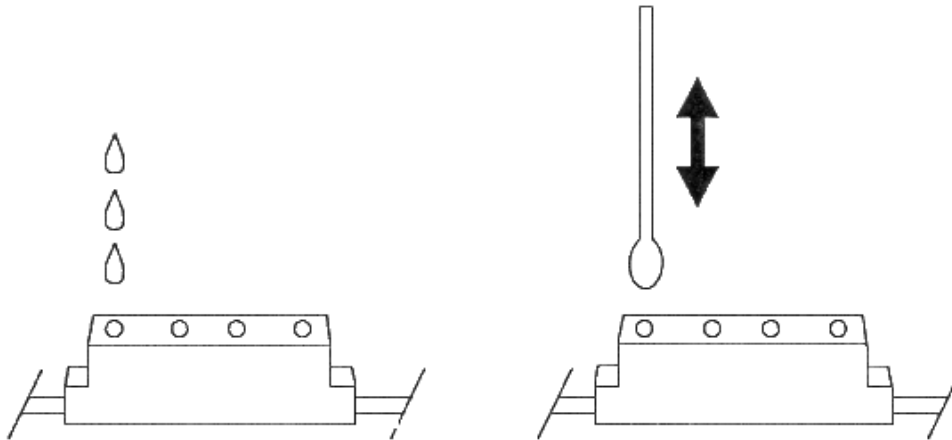

Figure A-3 Clean Cable Connectors as shown

- 3) Rinse the jack with a damp cloth swab and dry it with a dry swab.
- 4) Apply a small amount of silicone grease to a clean cotton swab and insert into the jack.

**Note:** If this process proves unsuccessful, you can use Lime-A-Way® in place of rubbing alcohol in severe cases of corrosion.

## **Touchpads and Buttons**

Make sure all connectors fit snugly into the cable harness. Connectors with broken prongs do not fit properly. Refer to Figure A-4. Check connector prongs for corrosion and clean or replace connectors as necessary. Refer to the Touchpad maintenance section in this chapter (page 72), and to your touchpad manual for detailed care instructions.

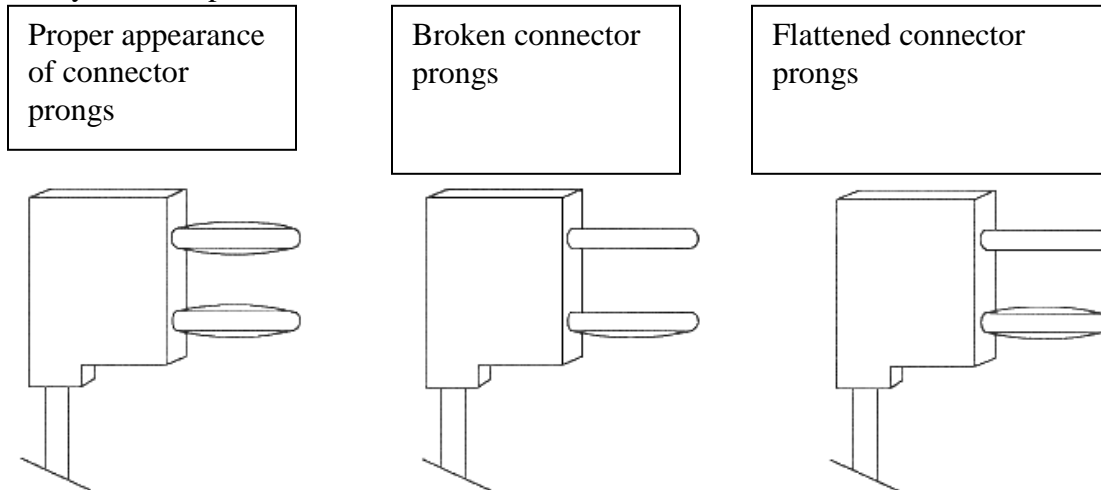

Figure A-4 Inspect Touchpad and Button Connectors

## **Start Systems**

Make sure all connectors fit snugly into the cable. Connector prongs that are broken fit loosely. Refer to Figure A-4. Check connector prongs for corrosion and clean or replace connectors as necessary. Refer to your Start System user's manual for detail on its proper maintenance.

## **Scoreboard**

Inspect the scoreboard data cable connectors for corrosion and broken or frayed wires. Clean or replace as necessary. Consult your scoreboard manual for any maintenance needed.

## **Printer**

Inspect the printer cable connectors for corrosion and broken or bent pins. Clean or replace as necessary. Consult your printer manual for instructions on caring for your printer.

# Troubleshooting

## Theory Of Operation

The Swimming system is made up of three component systems: input, output and the System 6. All three systems must be working properly to make a functioning Swimming system.

The input system includes a start system, relay judging, input computer and a finish system. The start system provides input data to the System 6, which tells the Swimming software to begin timing a race. The relay judging input provides relay exchange information. The input computer can be used to download meet management information to the System 6. The finish system (touchpads, backup buttons) provides input data to the System 6, which tells the Swimming software to record a given split or finish time.

The System 6 Sports Timer with Swimming software is the heart of the system. It receives and interprets input data and provides output to a variety of output devices.

The output system receives interpreted data from the System 6/Swimming software and provides these data in visual format. The basic output system consists of a printer to provide a hard copy of race results and a scoreboard to display the results to spectators. A more advanced output system also includes a computer running Meet Management software and a video output.

## Trouble Shooting Chart System 6 Swimming Software

Find the problem you are experiencing on the left and follow the remedy instructions and notes to the right.

The first step to troubleshooting is to ensure that your timer has the latest version of software by using the *Install* key in the sport loader menu (see page **Error! Bookmark not defined.**). Then try the suggested remedies **exactly as given, one at a time and in the order listed**. Be sure to record the remedies tried and their results for future reference.

<b>Problem</b>	<b>Remedy</b>	<b>Notes</b>
No display at all when power is turned on.	1) Check power adapter cable and wall outlet	
A swimming feature does not function as expected	Refer to Chapter 4 for a complete explanation of the feature in question.	If it still seems wrong, call CTS Customer Service.
Swimming race timer does not start.	1) Make sure start system cable is properly and securely attached.	Refer to Chapter 2 or your start system manual for instructions

	2) Clean Connectors.	Refer to page 64
	3) Check cabling.	Refer to page 65
	4) Check start system.	Refer to page 66 or start system manual.
Swimming software does not register pad or finish button/backup button.	1) The timer must be ready for a pad hit. Ensure that the pad armed indicator is displayed in the appropriate lane(s).	Refer to Chapter 4 for complete instructions
	2) Confirm that lane mapping is set properly for the lane(s).	Refer to Chapter 4, Setups Menu, Pool setups (page 46)
	3) Make sure touchpad and button cables are properly and securely connected.	Refer to Chapter 2
	4) Clean connectors	Refer to page 64
	5) Check cabling.	Refer to page 65
	6) Check touchpad(s) or button(s).	Refer to page 72

## Trouble Shooting Chart Input System

This section addresses input system problems only. Try the suggested remedies **exactly as given, one at a time and in the order listed**. Be sure to record the remedies tried and their results for future reference.

<b>Problem</b>	<b>Remedy</b>	<b>Notes</b>
Start system does not start race time	1) Make sure start system cable is properly attached.	Refer to Chapter 2 or start system manual for instructions
	2) Clean connectors.	Refer to page 64.
	3) Check cabling.	Refer to page 65
	4) Check start system.	Refer to page 71 or start system manual.



Finish system pad or finish button/backup button hits are not registered on the Swimming display screen.	<p>1) Swimming software must be ready for a pad hit. Ensure that the pad arm indicator is displayed in the appropriate lane(s).</p> <p>2) Make sure touchpad and button cables are properly and securely connected.</p> <p>3) Clean connectors</p> <p>4) Check cabling.</p> <p>5) Check touchpad(s) or buttons(s).</p>	<p>Refer to Chapter 4 for a complete explanation.</p> <p>Refer to Chapter 2 for cabling instructions.</p> <p>Refer to page 64</p> <p>Refer to page 65</p> <p>Refer to page 72</p>
Early and late relay departures are not indicated on chatter splits printout	Ensure that the RJP interface cable is connected to the RJP and to the Button A connector on the touchpad cable harness or deck plate.	Refer to Chapter 2 or the RJP manual for cabling instructions.
Button A backup times not indicated on display screen or printed on race printout.	Ensure that the backup buttons are connected to the stackable banana plug on the cable harness end of the RJP cable.	Refer to Chapter 2 or RJP manual for cabling instructions.
No Relay Judging Exchange or Summary printout.	Ensure that the desired printout options are listed in the print format setup.	Refer to Chapter 4 under Setups (page 44) for complete instructions.

## Trouble Shooting Chart Output System

This section addresses output system problems only. Try the suggested remedies **exactly as given, one at a time and in the order listed**. Record the remedies tried and their results for future reference.

Problem	Remedy	Notes
Printer does not print.	<p>1) Make sure printer is set <b>On-Line</b> and is loaded with paper.</p> <p>2) Make sure cable</p>	Refer to Chapter 2.

	<p>connections are secure.</p> <p>3) Clean printer cable connectors.</p> <p>4) Try pressing the <b>Form Feed</b> key</p>	<p>Refer to page 65</p> <p>Refer to page 39.</p>
Scoreboard not working at all.	<p>1) Make sure scoreboard has power and is turned on.</p> <p>2) Make sure scoreboard is not blanked.</p> <p>3) Make sure scoreboard cable is properly connected.</p> <p>4) Check scoreboard cable connectors for corrosion and clean or replace as necessary.</p>	<p>Refer to scoreboard manual.</p> <p>Refer to the <b>Scoreboard</b> softkey (page 41) and scoreboard Setups (page 47) sections in Chapter 4.</p> <p>Refer to Chapter 2.</p>
Scoreboard not showing expected results.	<p>1) Make sure scoreboard cable is properly connected.</p> <p>2) Check scoreboard cable connectors for corrosion and clean or replace as necessary.</p> <p>3) Ensure that scoreboard DIP switches for each module are set to the proper physical address.</p> <p>4) Check logical addresses in the Swimming software.</p>	<p>Refer to scoreboard manual.</p> <p>Refer to Chapter 2 and/or scoreboard manual for complete instructions.</p> <p>Refer to Setups in Chapter 4 (page 43), channel selection on page 16, or call Colorado Time Systems' Customer Service Department.</p>
Event Sequence Download does not work.	<p>1) Make sure <b>Allow Remote Setup</b> (page 44) is enabled in Setups/Hardware Setup.</p> <p>2) Exit <b>Setups</b>—you cannot</p>	<p>Refer to page 44 in this User Guide.</p>

	<p>download an event sequence if Swimming 6 is in setup mode.</p> <p>3) Make sure meet management cable is connected to Com Port 1 on your System 6 back panel.</p> <p>4) Refer to your meet management program manuals.</p>	<p>Refer to page 11 in this User Guide</p>
--	--	--

# Start System

## Electronic Start Systems

An electronic system sounds a start tone for the swimmers over a speaker and starts the Swimming race timer.

There are four possible problem areas:

- 1) The start system does not start the timer. The start tone and the PA both function.

This problem is usually the result of a faulty cable connection. Plug a working pushbutton into the **primary cable harness** connector labeled **start** and press the button. If the Swimming race timer does not start, refer to the Wiring section beginning on page 73. If the timer does start, check the cable that goes to the start system. The cable plugs should fit tightly into the jacks and should be free of corrosion. Clean or replace as necessary and repeat process. If the cable and plugs are okay, plug the start system cable into the **primary cable harness** and jumper the connector that normally plugs into the start system with a paper clip. If the Swimming race timer starts, the start system is defective and should be returned for service.

- 2) No start tone but the PA works.

This is usually a problem with the microphone. Plug a working pushbutton into the button start jack on the start system and press the button. If the start tone sounds, the microphone is defective and it should be returned for service. If no start tone sounds, the control board inside the start system is defective and it must be returned for service.

- 3) No start tone or PA but the Swimming race timer starts properly.

This is usually a bad speaker or speaker cable harness. Plug the speaker directly into the speaker output to eliminate the cable. If you do not use a speaker cable, use an ohm meter to check the

speaker. If it does not match the speakers' specification (printed on the speaker label), the speaker is defective.

4) No start tone, PA or start timer.

This usually indicates a low battery, blown fuse or a bad control board. The battery can be checked with a volt meter, the fuse can be checked with an ohmmeter. If the battery and fuse are okay, return the start system to the factory for repair.

### **RJP Judging Platforms**

Your RJP platforms are very durable and are designed to last with a minimal amount of routine maintenance. It is recommended that you regularly clean the cable connectors with rubbing alcohol and a cotton swab, as described earlier in this appendix. For Troubleshooting information, refer to your RJP Installation and Operation manual, P/N F507. To obtain a replacement manual, download the most recent version from our website, [www.coloradotime.com](http://www.coloradotime.com)

## **Finish System**

There are two types of finish systems: touchpads and pushbuttons. Both are simply momentary switches. Touchpads are large switches that are mounted on the pool wall while pushbuttons are used by judges standing next to the pool. Both types use a cable to connect to the Swimming race timer.

When either a touchpad or pushbutton switch closes, a split or finish time is recorded by the Swimming race timer. If a split or finish time is not recorded, the finish system has failed. There are three potential problems areas in a finish system: the touchpad or button, the in-deck cable or wiring harness, and finally, the System 6 itself. Start by checking the pad or button and then the cable. Finally, check the System 6.

### **Touchpads and Buttons**

These items can be checked easily with the touchpad button/tester (Model TPM-D) or ohm meter. Follow these steps:

- 1) Inspect the plugs for damage and corrosion. Clean or replace as necessary.
- 2) Plug the pad or button into the tester or attach one ohmmeter test lead to each connector pin on the pad or button cable.
- 3) Without touching the pad, the tester reads 0 to 20 or infinite resistance on an ohmmeter if the pad is good. Defective pads read 40 to 50 or show measurable resistance on an ohmmeter. Touchpads that read between 20 and 40 on the touchpad tester or show measurable resistance on

an ohmmeter should not be trusted. We recommend that they be sent in for evaluation and possible replacement. Defective buttons can generally be repaired at the factory.

4) Touch the pad. If the pad is working properly, the tester reads full scale or an ohmmeter reads less than 100 ohms. Be sure the battery in your touchpad meter or ohmmeter is properly charged. A weak battery yields inaccurate readings.

### **Touchpad Pressure**

A touchpad is essentially a switch in a waterproof container. To prevent the pad from floating, most of the air is removed at the factory. Three general rules for touchpad inflation apply:

1) Touchpads should not be over inflated because they will float away from the edge of the pool. A punctured touchpad allows air to enter during storage and must be returned to the factory for service.

2) Touchpads should not be under inflated. A properly inflated pad has a slight air bubble inside the pad at the water line.

3) Pad inflation should need to be adjusted only very rarely.

## **Wiring Systems**

Colorado Time Systems use two types of wiring systems: cable harness and in-deck wiring. Refer to the appropriate section below for your type of wiring system.

### **Cable Harness**

The cable harness is simply a multi-conductor cable that runs across the pool deck. The most common problems with cables are corroded connectors. Cleaning solves most problems. Refer to the connector cleaning instructions earlier in this chapter.

If suspected cable problems persist after cleaning the connectors, use a voltmeter to test the cable. Plug the suspect cable into the System 6 as described in chapter 2 and turn on your System 6. Insert the voltmeter test leads into each touchpad and button position on the cable, taking care to observe the polarity of each connector. The voltmeter should read 5 volts. If all cable connectors are okay, the touchpad or button is defective. Refer to the Finish System section for more information.

### **In-Deck Wiring**

Check an in-deck wiring system using the same procedure as outlined above for cable harnesses. Most in-deck wiring system problems are found at the wall plate connectors. Inspect the connectors and clean or replace as necessary.

# Printers

## Compatible Printers

There are two basic types of printers. One is a DOS type and takes an ASCII stream of data and prints it. The other is a Windows type of printer and needs a program loaded on your computer called a “Device Driver” in order to print. Many printers can do both.

Not every printer will work with the System 6. This is because most printers do not have device drivers or on-board DOS emulators and require your computer to perform all the formatting. Any printer that says it needs the Windows environment probably will NOT work.

Any printer that is compatible with PCL will work. This includes most HP laser printers and most Brother laser printers. The Okidata ML 320 is an acceptable dot matrix option.

Once you have a printer that will work with the System 6 you will need to load special codes into the timer in order to print non-standard print sizes. Most printers will print 10 characters per inch (10CPI) across the page as default (this is a good size print if you have a 6 lane pool). If you wish to print a smaller size (12CPI) for an 8-lane pool you will need to set the size on the printer or have print codes that the timer can send to the printer requesting the smaller size print. These print codes are loaded in the SETUPS area under the “printer” section.

### PCL Codes:

#### Citizen GSX190:

Pica:	27	51	48
Elite:	27	51	49
Condensed:	27	51	50
Super Cond:	27	51	55
6 LPI:	27	48	50 52
8 LPI:	27	48	49 56

#### HP-PCL:

Pica:	27	40	115	49	48	72
Elite:	27	40	115	49	50	72
Condensed:	27	40	115	49	54	72
Super Cond:	27	40	115	50	48	72
6 LPI:	27	38	108	54	68	
8 LPI:	27	38	108	56	68	

#### IBM:

Pica:	18	
Elite:	27	58
Condensed:	28	
Super Cond:	(none)	
6 LPI:	27	50
8 LPI:	27	48

#### Epson:

Pica:	27	80		
Elite:	27	77		
Condensed:	27	80	27	15
Super Cond:	27	77	27	15
6 LPI:	27	50		
8 LPI:	27	48		

#### Okidata:

Pica:	30		
Elite:	28		
Condensed:	29		
Super Cond:	27	35	51
6 LPI:	27	54	
8 LPI:	27	56	

#### Panasonic:

Pica:	27	80	18	
Elite:	27	80	27	77
Condensed:	27	80	15	
Super Cond:	(none)			
6 LPI:	(none)			
8 LPI:	(none)			

**Note:** Once you have pressed *Store/Print*, information is sent to the printer immediately. When your printer actually prints it depends on the type of printer: dot-matrix printers will begin printing immediately while laser printers will wait until the page is full before printing unless you press the *Form Feed* key.





# Appendix B: Glossary

## Introduction

This Glossary contains definitions of specialized terms used in this instruction manual. Terms are arranged alphabetically.

**Channel**: The hexadecimal code used in the Swimming software to direct information to a specific scoreboard destination or the hexadecimal code used in the scoreboard which tells a given scoreboard module what information to display. The physical address is determined by the switch settings in each scoreboard line. Often used interchangeably for both logical address and physical address. Channel is a less precise term which must be taken in the context used to determine if it refers to the logical address, physical address, or both.

**Hardware**: The physical equipment used to process information, as opposed to the software or programs that perform specific tasks. The System 6 Sports Timer is a hardware device that can run many different software programs. Swimming is a software program.

**Keypad Keys**: The keys on the membrane keyboard of the System 6.

**Liquid Crystal Display (LCD)**: A solid-state, low-current device used for computer displays when space and power consumption are at a premium. In this case, the System 6 Sports Timer display screen.

**Logical Address**: The hexadecimal code used in the Swimming software to direct information to a specific scoreboard destination. A logical address can be directed to any physical address except 0F, which is reserved for single-line scoreboards.

**Meet**: For Swimming, a “Meet” begins when you enter the Swimming Program on the System 6 Sports Timer for the first time after power up, and ends when when you exit from the Swimming Program back to the Choose Sport Menu for the last time before power down. Meets are stored in this way in Stored Data. This effectively creates one meet per power cycle. New Meets can also be created using the “Create New Meet” option in the Misc menu.

**Physical Address**: The hexadecimal code used in the scoreboard which tells a given scoreboard module what information to display. The physical address is determined by DIP switch settings in each scoreboard line.

**Prompt Box**: Appears on the Swimming display screen when the entry of information is required.

**Race**: For the Swimming software, a race begins when a start is received and continues until the next start is received. When *Store/Print* or *reset* is pressed, the race timing is completed, but the race just completed is still considered the current race.

**Reset State**: Reset state indicates that all swimmers have finished and that the current race is over. When you press reset, the Swimming software remains in reset state until the next start. The Swimming software is in reset start when you first load it.

**Scoreboard Module**: A scoreboard line set up to display specific information with DIP switches mounted in the module. This term is often used interchangeably with *physical address*.

**Signage**: The labels placed on the scoreboard that indicate what type of information a given digit or series of digits displays.

**Softkeys**: Keys whose function changes with what is displayed on the screen. On the System 6, the six keys located to the right of the screen.

**Software**: A computer program designed to perform specific tasks. Swimming is an example of software. Also known as program or software program.

**Toggle**: Like a light switch, a software toggle turns a given function on if it is presently off, or off if it is presently on.

# Appendix C:

## History of Swim Timing

Congratulations on the purchase of your new System 6 Sports Timer! You have chosen the latest sports timer from Colorado Time Systems, the company that pioneered precision and accuracy in swim timing. A legacy of excellence is behind your new timer.

In the early 1970s, Colorado Time Systems offered the first practical display timing and scoreboard system to the American marketplace. It featured easy-to-read final time displays plus the first “split time” display available on a swim timer. Our Printing Timer system, which incorporated a built-in paper strip printer, appeared a few years later. The Printing Timer provided an affordable, instantly printed split and final times at the end of each heat. It also included three buttons per lane backup timing with automatic comparison of touchpad and backup times. An optional standby battery system provided protection against loss of data in the event of an electrical power failure.

In the early 1980s, Colorado Time Systems introduced the third generation timing system that revolutionized the industry with innovative features -- the Swimming III timing system. New features included race memory to store previous race results, thereby speeding meet operation, a relay judging system and the use of a membrane keyboard with over-lays to replace obsolete button keyboards. The Swimming III timer quickly and easily converted to other aquatic sports simply by loading a different program cassette and changing the keyboard overlay. The Swimming III timer earned recognition as the performance standard of the industry from 1981 through 1989.

In the late 1980s, Colorado Time Systems introduced the next generation sports timer. The System 4000 included the industry’s first full-sized printer and meet management computer. A full range of sports timing programs were available on programmable cards. Installing a new program became as simple as inserting a new card into the slot on the System 4000 rear panel. The System 4000 set the pace in the sports timing industry in its time.

The System 5 Sports Timer continued Colorado Time Systems’ tradition of using advanced technology to provide beneficial new features. A large LCD screen with contrast control enabled the operator to see at a glance the entire race situation, including the status of each lane. The ease of operation built into the System 4000 was further advanced in the System 5. Most keyboard operations required only a single keystroke. The System 5 also incorporated output for meet management software and expanded race memory with enough space to store the entire meet’s results--all-important innovations in swim timing. Meet efficiency benefitted since a race could

be started as soon as the previous race was completed. All race information could be printed in many different formats at the operator's convenience with an economical, full sized 8 1/2 by 11 inch line printer.

The System 5 Sports Timer incorporated a self-diagnostic system to check the timer's internal circuitry and components. The diagnostics program also ran circuitry checks on the cable harness, touchpads, pushbuttons and scoreboard cable when these items are properly connected.

New programs for other sports were provided on diskette and downloaded from a personal computer to the System 5's internal memory. Once downloaded, the new programs remained in the System 5, ready to be used at a single keystroke. New programs and program updates were easily incorporated using this innovative system.

This full range of features built into the System 5 Sports Timer meant that it was the industry leader ever since it came out.

With the advent of the System 6, users can take advantage of these existing features and the addition of a larger and full color screen, external mouse and PC keyboard, support for 12-lane pools, additional input and output capabilities, automatic updating of firmware and software, automatic calculation of adjusted backup times (USA Swimming, NCAA and High School rule), enhanced relay judging capabilities, enhanced handling of one line scoreboards, ability of displaying subtracted and running splits simultaneously on LED matrix boards and the possibility of continued software features.

# Appendix D: Scoreboard Definitions

## Scoreboard Module configurations

LN	PL	TIME	Channel Number		EVENT	HEAT
1	0	00:00.00	01/11*	0C	000	000
2	0	00:00.00	02		HOME	GUEST GUEST
3	0	00:00.00	03	0D/11*	000	00 000
4	0	00:00.00	04		1 2 3 4 5 6 7 8	
5	0	00:00.00	05	0E	0 0 0 0 0 0 0 0	
6	0	00:00.00	06	12**	0 0 00:00.00	
7	0	00:00.00	07		HOME	G1 G2 G3
8	0	00:00.00	08	13	00 00 00 00	
9	0	00:00.00	09		HOME	GUEST 1
A	0	00:00.00	0A	14	0000	0000
b	0	00:00.00	17		GUEST 2	GUEST 3
C	0	00:00.00	18	15	0000	0000
		LENGTHS		16		00:00
		RECORD	0B			
		00 00:00.00				

Channel 11 is a multi-purpose channel that displays time and place information for lane 1 (channel 01) during the race. Following reset, team scores (channel 0D) are automatically displayed on the same scoreboard module.

Channel 12 is a special purpose channel, which is very useful for televised broadcasts. It displays the running time, lead split time and winning finish time. Unlike channel 0F, this channel does not cycle through all finish times, but displays only winning time until it is reset

HOME		GUEST	
0d		0d	
EVENT		HEAT	
0C		0C	
LENGTHS		RECORD	
0b		0b	
LN	PL	TIME	
0	1	01	
0	2	02	
0	3	03	
0	4	04	
0	5	05	
0	6	06	

When you are done setting the channel switches in your scoreboard, check the configuration. Press 2-Show definitions on scoreboard in the Scoreboard Setup menu to display the module definitions on the scoreboard as shown in above. Refer to page 47 for more information

## Swimming Sample Templates for Matrix and Video Boards

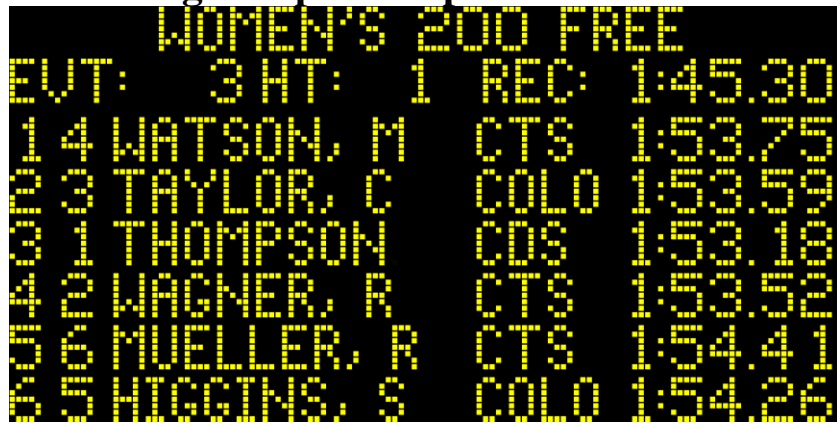

WOMEN'S 200 FREE

EVT:	3	HT:	1	REC:	1:45.30
1	4	WATSON, M	CTS	1:53.75	
2	3	TAYLOR, C	COLO	1:53.59	
3	1	THOMPSON	CDS	1:53.19	
4	2	WAGNER, R	CTS	1:53.52	
5	6	MUELLER, R	CTS	1:54.41	
6	5	HIGGINS, S	COLO	1:54.26	

64x128-Pixel LED Matrix or Video Board

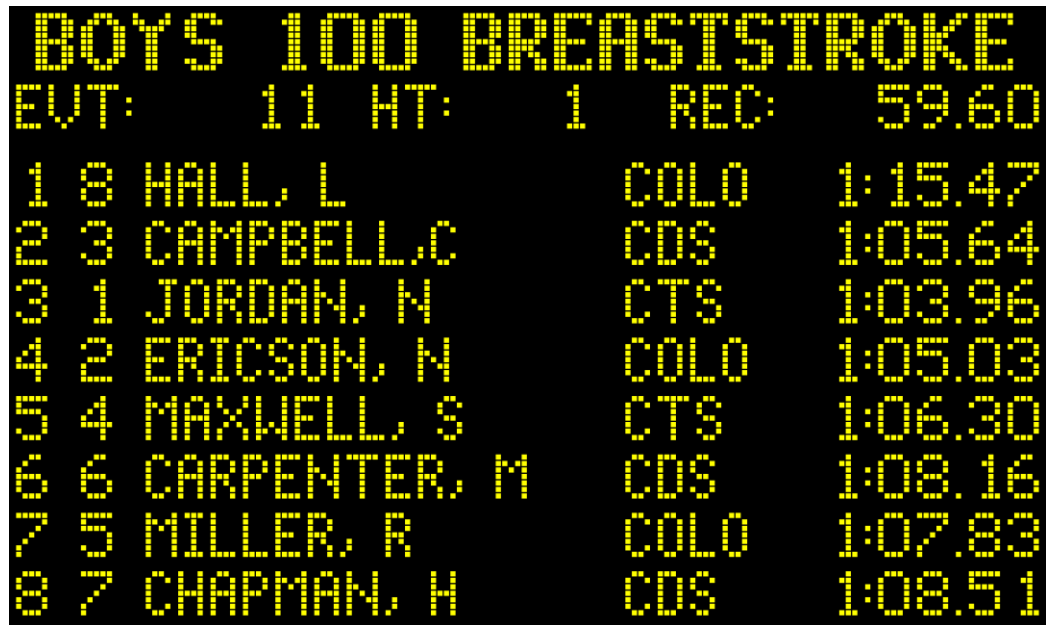

BOYS 100 BREASTSTROKE

EVT:	11	HT:	1	REC:	59.60
1	8	HALL, L	COLO	1:15.47	
2	3	CAMPBELL, C	CDS	1:05.64	
3	1	JORDAN, N	CTS	1:03.96	
4	2	ERICSON, N	COLO	1:05.03	
5	4	MAXWELL, S	CTS	1:06.30	
6	6	CARPENTER, M	CDS	1:08.16	
7	5	MILLER, R	COLO	1:07.83	
8	7	CHAPMAN, H	CDS	1:08.51	

96x160-Pixel LED Matrix or Video Board

WOMEN'S 50 FREE				TOD: 9:36	
EVENT: 4		HEAT: 1		REC:	21.87
1	7	DAVIS, N	CDS	11.73	22.27
2	6	GIBBS, J	COLO	11.53	22.18
3	3	GRAHAM, H	CTS	11.37	22.09
4	1	PRICE, T	COLO	11.22	21.98
5	2	MORTON, G	CTS	11.21	22.03
6	4	MARTIN, S	CDS	11.26	22.11
7	5	LEWIS, B	COLO	11.50	22.17
8	8	STEWART, P	CTS	11.78	22.35

96x192-Pixel LED Matrix or Video Board



# Appendix E:

## Swimming Software Menu Tree

Print-page 38

Race Summary-page 39

Splits/Summary-page39

Relay Summary-page 39

Form Feed-page39

Quick Options-page 39

Far End On/Off-page 40

Display Lanes On/Off-page 40

Backstroke Start Reaction-page 40

Post Race by Place-40

Event/Heat and Home/Guest-page 41

Scoreboard-page 41

Step Data-page 41

Clear Lanes-page 41

Scoreboard Blank-page 41

Scoreboard On-page 42

Team Scores-page 42

Record Time-page 42

Setups-page 43

SCREEN

Start/Finish-page 43

Start Even-Length Races at Near/Far End-page 44

Start Odd-Length Races at Near/Far End-page 44

Do/Do NOT Clear Lanes Automatically-page 44

Do/Do NOT Show Start Reaction Times on Scoreboard-page 44

Near End Primary Finish=Pad/Button(s)-page 44

Far End Primary Finish=Pad/Button(s)-page 44

Do/Do NOT Blink Time for Record Breaker-page 44

Do/Do NOT Post Intermediate Place on Scoreboard- page 44

Hardware-page 44

Speaker Volume-page 44

Backlight Intensity-page 44

Remote Setup allowed/not allowed-page 44

Relay Judging using Platforms/Buttons (Near End)-page 45

Relay Judging using Platforms/Buttons (Far End)-page 45

Relay Judging Interval-page 45

Far End Splits Used/Not Used-page 45

Do/Do NOT use start reaction times-page 45

Do/Do NOT use backstroke start reaction times-page 45

Scoreboard Intensity-page 45

- Timing-page 45
  - Timing Precision-page 45
  - Use/Do NOT Use Automatic Backup Time Adjustment-page 45
  - Near-End Pad Split Delay-page 45
  - Far-End Pad Split Delay-page 45
  - Display/Do NOT Display Time Warning Messages-page 45
  - Pad Delay at Start-page 46
  - Scoreboard Lengths Count Up/Down-page 46
  - Screen Lengths Count Up/Down-page 46
  - Show -----/Time on DQ-page 46
  - Pad to Backup Comparison Interval-page 46
- Pool-page 46
  - Lane Mapping-page 46
    - Lanes Normal-page 46
    - Reverse Lanes-page 46
    - Shift Lanes Up-page 46
    - Shift Lanes Down-page 46
  - Lanes in Pool-page 47
  - Lanes Used-page 47
  - Pool Length-page 47
  - Race Distance Units-page 47
- Scoreboard-page 47
  - Self Test-page 47
  - Define Module(s)-page 47
    - Define Scoreboard Module-page 47
    - Show Definitions on Scoreboard-page 47
  - Blank Module(s)-page 48
    - Blank/Unblank Scoreboard Module-page 48
  - (#)-Line Scoreboard-page 49
  - Times to Step One-Line Scoreboard-page 49
  - One-Line Scoreboard Sequence Time-page 49
  - One-Line Scoreboard Sequence List-page 49
  - Display Results in Lane/Place Order-page 50
  - Scoreboard Splits-page 50
  - Do/Do NOT Emulate 10 Lane Scoreboard-page 50
- Printer-page 50
  - Store/Print Format-page 51
  - View/Edit Sponsor's Message-page 51
  - Always Print/Do NOT Always Print on Store/Print Key-page 51
  - User Defined Printer Control Codes-page 51
  - Type Size-page 51
  - Lines Per Inch-page 52
  - Printer-page 52
  - Space for Minutes/Hours in Printouts-page 52
  - Do/Do NOT Show Event Sequence Title in Header-page 52
- Event Sequence-page 54

- Set Date/Time-page 57
  - Set Time of Day-page 57
  - Set Date-page 57
  - 12 Hour/24 Hour Clock-page 57
- Wireless-page 57
- SOFTKEYS
  - Up
  - Down
  - Save Setups
  - Restore Defaults
- Stored Data-page 57
  - Next Race page 58
  - Previous Race page 58
  - Next Event page 58
  - Previous Event page 58
  - Print Race-page 58
  - Print Yes/No-page 58
  - False Start-page 59
  - Edit/DQ-page 59
  - Scoreboard Post-page 59
  - Next Meet-page 60
  - Previous Meet-page 60
  - Print Meet-page 60
- Misc-page 60
  - Pad Power On/Off-page 60
  - Shutdown-page 60
  - Change Sport-page 60
  - Colors-page 61
  - Create New Meet-page 61



# Index

+  
+Touch Key, 32

## B

Backup Buttons, 8, 43  
Basic Operation  
    Modes of Operation, 25–28  
    Relay Judging, 28  
    Timing Corrections, 27  
    User Interface, 26  
    Warning Messages, 27  
Batteries, 2, 61  
Battery Check Key, 35  
Battery Compartment, 2, 61  
Blank Scbd, 40  
Button Finish, 7, 42

## C

C/E (Clear Entry) Key, 35  
Cables  
    Cleaning, 63  
Clear Lanes, 40  
Console Keys, 35  
    Battery Check, 35  
    Enter, 35  
    Help, 35  
    Quit, 35  
Customer Service, 3, 61

## D

Downloading Sports Programs, 59

## E

Edit Event/Heat Key, 31  
Edit/DQ Key, 32  
Enter Key, 34  
Event Sequence, 25–30, 31, 52–59  
Events Key, 33

## F

False Start, 58

Finish Arm Key, 22–23, 29  
Finish Systems  
    Backup Buttons, 6, 42  
    Button Finish, 7, 43  
    Touchpads, 6, 43

## H

Hardware Setup  
    Diagrams, 5–11  
    Finish Systems, 6–11  
    Start Systems, 5–6, 42  
Help Key, 35

## I

I/O Panel, 1, 11–14  
Internal Speaker Volume, 43

## K

Keyboard, 2–3, 29–35  
    +Touch, 32  
    C/E (Clear Entry), 35  
    Edit Event/Heat, 31  
    Edit/DQ, 32  
    Enter, 34  
    Events, 33  
    Finish Arm, 22–23  
    Finish Arms, 29  
    Lane On/Off, 29  
    Next Event, 31  
    Next Heat, 31  
    Reset, 34  
    Split Arm, 21–22, 30  
    Start, 20, 30  
    Store/Print, 23, 30–31  
    -Touch, 33

## L

Lane On/Off Key, 29  
Lane Order, 48  
Lanes in Pool, 47  
LCD Display, 1–2, 25–26, 62, 75  
Length of Pool, 45

Length Warning, 23  
Logical Address, 46, 47, 75

## M

Meet Management Software, 14, 56–57  
Misc Softkey, 56–60  
Modes of Operation, 1, 25–28

## N

Next Event Key, 31  
Next Heat Key, 31  
Numeric Keypad, 34  
    C/E (Clear Entry) Key, 35  
    Enter Key, 35

## P

Pad Warning, 27  
Post Race by Place, 39  
Power On/Off, 12  
Print Sofkey, 37–38  
Print Softkey  
    Form Feed, 38  
    Race Summary, 38  
    Relay Summary, 38  
    Splits/Summary, 38  
Printer Control Codes, 50, 72  
Printing  
    Backup Times, 44  
    On Store/Print, 34  
    Sample Printouts, 51–52  
    Setup Options, 42–51  
    Split Times, 38  
    Stored Data, 56–59  
    Troubleshooting, 72  
    Type Size, 49–50

## Q

Quick Options Softkey, 38–40  
    Display Lanes, 39  
Quit Key, 35

## R

Record Time, 41  
Reducing Corrosion, 63–64  
Relay Judging, 28–29, 44

Sample Printouts, 51  
Remote Setup, 43  
Reset Key, 20, 34  
Reset State, 76  
Reverse Lane Numbering, 45

## S

Scbd Blank, 41  
Scbd On, 41  
Scoreboard Configuration  
    Blank Module(s), 47  
    Channel, 16–17  
    Define Modules, 46–49  
    Logical Address, 75  
    Module, 76  
    Mult-Line Scbd, 16–17  
    One-Line Sequence, 46–49  
    Physical Address, 75  
    Self-Test, 46  
    Show Module Definitions, 16, 47  
    Single-Line Scbd, 15, 46  
    Single-Line Sequence, 46–49  
    Software Setup, 42  
Scoreboard Module, 76  
Scoreboard Softkeys, 40–41  
    Clear Lanes, 40  
    Record Time, 41  
    Scbd Blank, 41  
    Scoreboard On, 41  
    Scoreboard On/Blank, 41  
    Step Data, 40  
    Team Scores, 41  
Setup  
    Allow Remote Setup, 43  
Setups Sofkey  
    Start/Finish, 42  
Setups Softkey, 42–56  
    Event Sequence, 52–54  
    Hardware Setup, 43  
    Pool, 45  
    Printer, 49–50  
    Scoreboard, 46–49  
    Start, 42–43  
    Summary, 42  
    Time/Date, 56  
Softkeys, 2, 35–60

- Misc, 56–60
- Print, 37–38
- Quick Options, 38–40
- Scoreboard, 40–41
- Setups, 42–56
- Stored Data, 56–59
- Split Arm Key, 21–22, 30
- Sports Menu, 20, 25
- Start Key, 20, 30
- Start Systems
  - Hardware Setup, 6
  - Software Setup, 42–43
- Starting Swimming, 25
- Step Data, 40
- Store/Print Key, 23, 30–31, 49–50
- Stored Data Softkey, 57
  - Edit/DQ, 58
  - False Start, 58
  - Next Event, 57
  - Next Meet, 59
  - Next Race, 57
  - Previous Event, 57
  - Previous Meet, 59
  - Previous Race, 57
  - Print Yes/No, 58
  - Scoreboard Post, 58

- System Setup
  - Diagrams, 5–11
  - Finish Systems, 6–9
  - Start Systems, 5–6
- System Test, 18

## T

- Team Scores, 41
- Time/Date, 56
- Timing Corrections, 28
- Timing Problems, 27
- Timing Problems Screen, 27–28
- Touch Key, 33
- Touchpad Split Delay, 44
- Touchpads, 6

## U

- User Interface, 26
  - LCD Display, 2, 26, 62, 75

## W

- Warning Messages
  - Pad, 27